

DEVELON

Crawler Excavator

DX420LC-7



Engine

Make	Scania
Model	DC13
Number of cylinders	6
Rated power, gross (hp per SAE J1995)	344.6 hp (257 kW) @ 1800 rpm
Rated power, net (hp per SAE J1349)	337.9 hp (252 kW) @ 1800 rpm
Max. torque, net (SAE J1995)	1144 lbf.ft. (1550 Nm) @ 800–1500 rpm
Displacement	755 in. ³ (12.7 L)
Bore and stroke	5.1 in. x 6.3 in. (130 mm x 160 mm)
Starter	24 V, 8.0 hp (6.0 kW)
Battery	2 x 12 V, 200 AH, 1300 CCA
Alternator	28 V, 100 amp
Air cleaner	Three-stage

Hydraulics

Main pumps	2 x 95.0 gpm (2 x 360 L/min.)
Pilot pump (gear design)	6.3 gpm (24 L/min.)
Relief pressure (normal mode)	4700 psi (330 kg/cm ²)
Relief pressure (port relief)	5400 psi (380 kg/cm ²)

Working Pressure

Boom/arm/bucket (normal mode)	4694 psi (330 kg/cm ²)
Boom/arm/bucket (power boost)	4980 psi (350 kg/cm ²)
Travel	4694 psi (330 kg/cm ²)
Swing	3980 psi (280 kg/cm ²)

Undercarriage

Upper rollers (each track)	2
Lower rollers (each track)	8
Number of shoes (links per side)	50
Total length of track	17' 0" (5200 mm)

Swing Mechanism

Swing speed	0 – 9.6 rpm
Swing torque	95837 lbf.ft. (13250 kgf-m)

Drive System

Travel speed (low – high)	2.05 – 3.36 mph (3.3 – 5.4 km/h)
Traction force, max. (drawbar pull)	83335 lbf.ft. (37800 kgf-m)
Max. grade (limited by engine lub)	70% (35°)

Environment

Sound level (2000/14/EC)	105 dB(A)
Cabin sound level (ISO 6396)	71 dB(A)

Refill Capacities

Fuel tank	166.4 gal. (630 L)
DEF tank	16.6 gal. (63 L)
Cooling system (radiator capacity)	13.9 gal. (53.5 L)
Engine oil (with filler)	11.8 gal. (45 L)
Swing drive	2.1 gal. (8 L)
Final drive (each side)	1.8 gal. (7 L)
Hydraulic system	97.7 gal. (370 L)
Hydraulic tank	70 gal. (265 L)

Hydraulic Cylinders

Boom ¹ (2) bore x rod diameter x stroke	Mono boom	6.7 in. x 4.5 in. x 58.5 in. (170 mm x 115 mm x 1485 mm)
	2-PC boom (lower)	–
	2-PC boom (upper)	–
Arm ^{1,2} (1) bore x rod diameter x stroke		7.1 in. x 4.7 in. x 71.7 in. (180 mm x 120 mm x 1850 mm)
Bucket ¹ (1) bore x rod diameter x stroke	STD	6.3 in. x 4.3 in. x 52.0 in. (160 mm x 110 mm x 1320 mm)
	SLR*	–

¹ Cushion on rod end

² Cushion on base end

The piston rods and cylinder bodies are made of high-strength steel. A shock-absorbing mechanism is fitted in all cylinders to ensure shock-free operation and extended piston life.

NOTE: Where applicable, dimensions are in accordance with Society of Automotive Engineers (SAE) and ISO standards. Specifications and design are subject to change without notice. All dimensions are given for DEVELON excavators equipped with standard tracks and the standard front as listed. Pictures of DEVELON excavators may show other than standard equipment. All dimensions are shown in inches. Respective metric dimensions are enclosed by parentheses. Rounding may impact specifications. DEVELON equipment is manufactured with a Quality Management System that is in compliance with ISO 9001:2008.

Dimensions

		Standard Arm 35.4" (900 mm) TG Shoe (US20)	Long Arm 35.4" (900 mm) TG Shoe (US30)
Boom length		22' 0" (6700 mm)	
Arm length		10' 8" (3250 mm)	13' 0" (3950 mm)
Bucket type (SAE)		2.51 yd ³ (1.92 m ³)	
Track type		Fixed	
Tail swing radius	A ₁	12' 4" (3760 mm)	
Tail swing overhang (rear)	A ₂	3' 10" (1160 mm)	
Tail swing overhang (side)	A ₃	6' 4" (1935 mm)	
Shipping height (boom)	B	11' 0" (3355 mm)	11' 1" (3390 mm)
Shipping height (hose)	C	11' 4" (3466 mm)	11' 6" (3495 mm)
Shipping length	D	38' 6" (11740 mm)	
Shipping width	E	12' 0" (3650 mm)	
Counterweight clearance*	F	4' 2" (1270 mm)	
Cabin height	G	10' 6" (3210 mm)	
Upper structure width	H	9' 10" (2990 mm)	
Cabin height above house	I	2' 10" (855 mm)	
Cabin width	J	3' 4" (1010 mm)	
Tumbler distance	K	13' 11" (4250 mm)	
Overall track length	L	17' 1" (5205 mm)	
Undercarriage width	M	12' 0" (3650 mm)	
Track gauge	N	9' 0" (2750 mm)	
Track shoe width	O	35.4" (900 mm)	
Track height*	P	3' 6" (1070 mm)	3' 6" (1070 mm)
Car body clearance*	Q	1' 11" (583 mm)	

*Without shoe grouser height (36 mm)

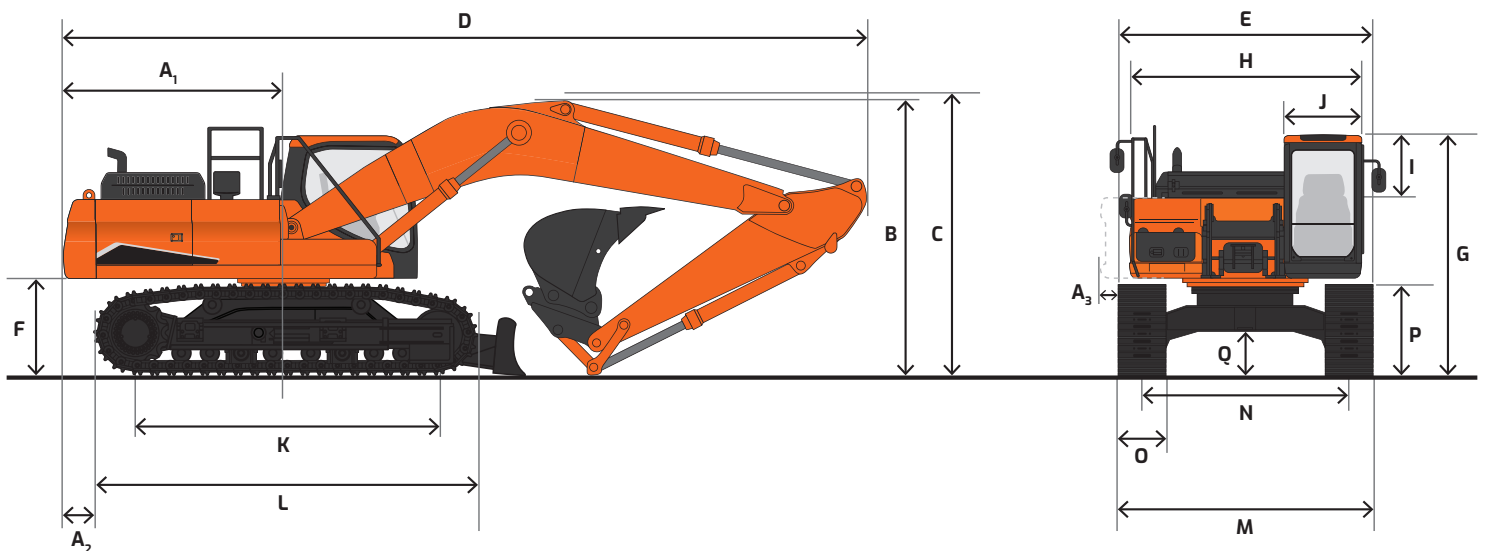

Working Range

		Standard Arm 35.4" (900 mm) TG Shoe (US20)	Long Arm 35.4" (900 mm) TG Shoe (US30)
Boom length		22' 0" (6700 mm)	
Arm length		10' 8" (3250 mm)	13' 0" (3950 mm)
Bucket type (SAE, PCSA)		2.51 yd ³ (1.92 m ³)	2.15 yd ³ (1.64 m ³)
Track type		Fixed	
Max. digging reach	A	37' 6" (11430 mm)	39' 9" (12120 mm)
Max. digging reach (ground)	B	36' 9" (11210 mm)	39' 1" (11910 mm)
Max. digging depth	C	25' 0" (7635 mm)	27' 4" (8335 mm)
Max. loading height	D	25' 7" (7810 mm)	26' 11" (8200 mm)
Min. loading height	E	10' 2" (3095 mm)	7' 10" (2395 mm)
Max. digging height	F	34' 10" (10615 mm)	36' 3" (11045 mm)
Max. bucket pin height	G	31' 1" (4985 mm)	32' 5" (9875 mm)
Max. vertical wall depth	H	10' 1" (3075 mm)	12' 6" (3815 mm)
Max. radius vertical	I	33' 2" (10105 mm)	34' 4" (10475 mm)
Max. depth to 8' line	J	24' 6" (7455 mm)	26' 10" (8185 mm)
Min. radius to 8' line	K	11' 2" (3415 mm)	11' 4" (3465 mm)
Min. digging reach	L	2' 7" (800 mm)	8" (205 mm)
Min. swing radius	M	14' 8" (4475 mm)	14' 11" (4555 mm)
Bucket angle (DEG)	d	177°	
Digging force, bucket (PCSA)*	ISO	64375 lbf. (29200 kgf)	65035 lbf. (29500 kgf)
Digging force, arm*		46740 lbf. (21200 kgf)	39905 lbf. (18100 kgf)
Operating weight		102594 lb. (46536 kg)	103256 lb. (46836 kg)
Ground pressure		7.82 psi (0.56 kg/cm ²)	8.1 psi (0.57 kg/cm ²)

*With power boost ON

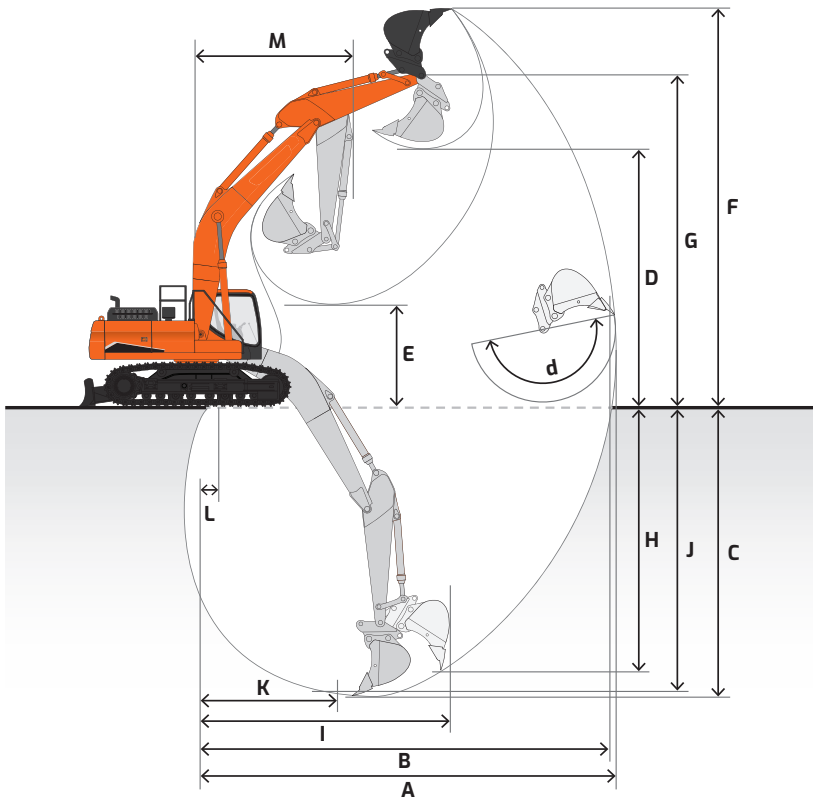

Lifting Capacity

Rating over front Rating over side or 360°

DX420LC-7 US20

Boom: 22' 0" (6700 mm) | Arm: 10' 8" (3250 mm) | Counterweight: 21600 lb. (9800 kg) | 35.4" (900 mm) Shoes | Bucket: None | Unit: lb. (kg)

A (ft. or m) B (ft. or m)	5' (1.5 m)		10' (3.0 m)		15' (4.5 m)		20' (6.0 m)		25' (7.5 m)		30' (9.0 m)		Max. Reach		
															A
30' (9.0 m)													* 21100 (* 9570)	* 21100 (* 9570)	22.99' (6.92 m)
25' (7.5 m)									* 22920 (* 10400)	* 22920 (* 10400)			* 20400 (* 9250)	* 20400 (* 9250)	26.85' (8.15 m)
20' (6.0 m)									* 23830 (* 10810)	* 23830 (* 10810)			* 19960 (* 9050)	17960 (8150)	29.51' (8.97 m)
15' (4.5 m)					* 38580 (* 17500)	* 38580 (* 17500)	* 30140 (* 13670)	* 30140 (* 13670)	* 25920 (* 11760)	23420 (10620)	* 23670 (* 10740)	17690 (8020)	* 20200 (* 9160)	16210 (7350)	31.14' (9.48 m)
10' (3.0 m)					* 48680 (* 22080)	47070 (21350)	* 34960 (* 15860)	31060 (14090)	* 28470 (* 12910)	22560 (10230)	* 24840 (* 11270)	17270 (7830)	* 21030 (* 9540)	15310 (6950)	31.94' (9.73 m)
5' (1.5 m)					* 43990 (* 19960)	* 43990 (* 19960)	* 38890 (* 17640)	29710 (13470)	* 30740 (* 13940)	21790 (9890)	25510 (11570)	16860 (7650)	* 22560 (* 10230)	15050 (6830)	31.95' (9.74 m)
Ground Level					* 48700 (* 22090)	43870 (19900)	* 40920 (* 18560)	28890 (13110)	* 32100 (* 14560)	21260 (9640)	25200 (11430)	16580 (7520)	23340 (10580)	15400 (6990)	31.18' (9.52 m)
-5' (-1.5 m)			* 34700 (* 15740)	* 34700 (* 15740)	* 54380 (* 24670)	43800 (19870)	* 40790 (* 18500)	28600 (12970)	* 32040 (* 14530)	21030 (9540)	25160 (11410)	16530 (7500)	25110 (11390)	16510 (7490)	29.57' (9.03 m)
-10' (-3.0 m)	* 42510 (* 19280)	* 42510 (* 19280)	* 54600 (* 24770)	* 54600 (* 24770)	* 50010 (* 22680)	44210 (20050)	* 38300 (* 17370)	28740 (13040)	* 29820 (* 13530)	21160 (9600)			* 26010 (* 11800)	18830 (8540)	26.96' (8.25 m)
-15' (-4.5 m)			* 55400 (* 25130)	* 55400 (* 25130)	* 42160 (* 19120)	* 42160 (* 19120)	* 32300 (* 14650)	29370 (13320)					* 25900 (* 11750)	23840 (10820)	22.99' (7.06 m)

A Distance from center of rotation
B Height

NOTE: Lifting capacities are in compliance with SAE 1097 and ISO 10567. Machine in lifting mode with power boost turned on. Load point is the end of the arm. Rated loads shown do not exceed 75% of minimum tipping loads or 87% of hydraulic capacities. Rated loads marked with an asterisk (*) are limited by hydraulic capacities. The least stable position is over the side. The total mass of machine includes the mass of the boom, arm, counterweight, all operating fluids and 165 lb. (75 kg) operator.

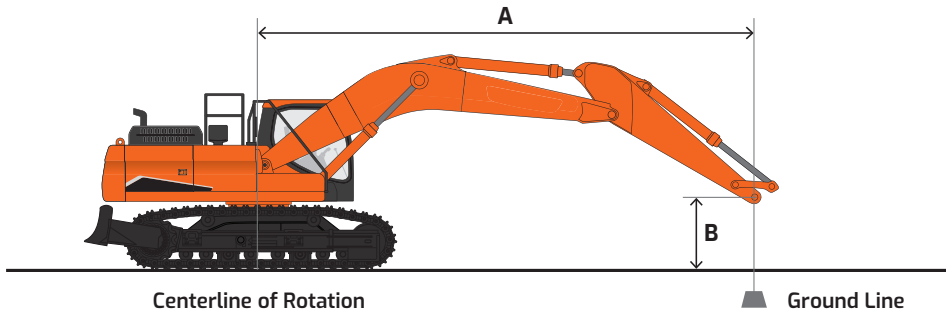















Lifting Capacity

 Rating over front  Rating over side or 360°

DX420LC-7 US30

Boom: 22' 0" (6700 mm) | Arm: 13' 0" (3950 mm) | Counterweight: 21600 lb. (9800 kg) | 35.4" (900 mm) TG Shoes | Bucket: None | Unit: lb. (kg)

A (ft. or m) B (ft. or m)	5' (1.5 m)		10' (3.0 m)		15' (4.5 m)		20' (6.0 m)		25' (7.5 m)		30' (9.0 m)		Max. Reach		
															A
30' (9.0 m)									* 20270 (* 9190)	* 20270 (* 9190)			* 16920 (* 7670)	* 16920 (* 7670)	25.82' (7.87 m)
25' (7.5 m)									* 19860 (* 9010)	* 19860 (* 9010)			* 15890 (* 7210)	* 15890 (* 7210)	29.42' (8.97 m)
20' (6.0 m)									* 21050 (* 9550)	* 21050 (* 9550)	* 20480 (* 9290)	17430 (7900)	* 15520 (* 7040)	15230 (6910)	31.86' (9.71 m)
15' (4.5 m)							* 26450 (* 12000)	* 26450 (* 12000)	* 23300 (* 10570)	22720 (10310)	* 21500 (* 9750)	17040 (7730)	* 15620 (* 7080)	13850 (6280)	33.39' (10.18 m)
10' (3.0 m)					* 42530 (* 19290)	* 42530 (* 19290)	* 31510 (* 14290)	30250 (13720)	* 26070 (* 11830)	21760 (9870)	* 22970 (* 10420)	16520 (7490)	* 16130 (* 7320)	13100 (5940)	34.14' (10.41 m)
5' (1.5 m)					* 50630 (* 22970)	43370 (19670)	* 36080 (* 16360)	28630 (12980)	* 28720 (* 13030)	20850 (9460)	* 24440 (* 11090)	16010 (7260)	* 17100 (* 7760)	12850 (5830)	34.16' (10.41 m)
Ground Level			* 20670 (* 9380)	* 20670 (* 9380)	* 52180 (* 23670)	41800 (18960)	* 39070 (* 17720)	27520 (12480)	* 30660 (* 13910)	20150 (9140)	24030 (10900)	15600 (7080)	* 18690 (* 8480)	13070 (5930)	33.46' (10.2 m)
-5' (-1.5 m)	* 23470 (* 10650)	* 23470 (* 10650)	* 32520 (* 14750)	* 32520 (* 14750)	* 54440 (* 24690)	41300 (18730)	* 40060 (* 18170)	26970 (12230)	31040 (14080)	19760 (8960)	23810 (10800)	15400 (6980)	* 21210 (* 9620)	13840 (6280)	31.99' (9.75 m)
-10' (-3.0 m)	* 35880 (* 16270)	* 35880 (* 16270)	* 47050 (* 21340)	* 47050 (* 21340)	* 51750 (* 23470)	41450 (18800)	* 38900 (* 17640)	26900 (* 12200)	* 30470 (* 13820)	19710 (8940)	* 23800 (* 10800)	15510 (7030)	* 23670 (* 10730)	15460 (7010)	29.6' (9.02 m)
-15' (-4.5 m)	* 50520 (* 22910)	* 50520 (* 22910)	* 63530 (* 28820)	* 63530 (* 28820)	* 46010 (* 20870)	42130 (19110)	* 35010 (* 15880)	27300 (* 12380)	* 26670 (* 12100)	20090 (9110)			* 24030 (* 10900)	18670 (8470)	26.09' (7.95 m)
-20' (-6.0 m)			* 47540 (* 21560)	* 47540 (* 21560)	* 35430 (* 16070)	* 35430 (* 16070)	* 25900 (* 11750)	* 25900 (* 11750)					* 23390 (* 10610)	* 23390 (* 10610)	20.87' (6.36 m)

A Distance from center of rotation
B Height

NOTE: Lifting capacities are in compliance with SAE 1097 and ISO 10567. Machine in lifting mode with power boost turned on. Load point is the end of the arm. Rated loads shown do not exceed 75% of minimum tipping loads or 87% of hydraulic capacities. Rated loads marked with an asterisk (*) are limited by hydraulic capacities. The least stable position is over the side. The total mass of machine includes the mass of the boom, arm, counterweight, all operating fluids and 165 lb. (75 kg) operator.

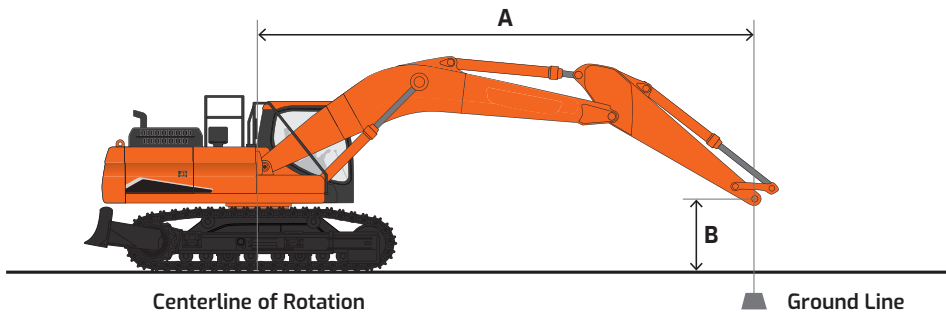

Standard & Optional Equipment

■ Standard ● Optional

Engine

Emissions (EPA)	T4f
High-pressure common-rail (HPCR)	■
Variable geometry (VGT)	■
Cooled exhaust gas recirculation (CEGR)	■
Selective catalyst reduction (SCR)	■
Diesel exhaust fluid (DEF)	■
Fuel filter with water separator	■
Coolant expansion tank	■
Dual element dry-type air filter with evacuator	■
Precleaner	■
Electronic engine control (ECU)	■
Auto idle	■
Auto shutdown (time-adjustable)	■
Overheat & low oil pressure engine protection	■
Block heater (110 V)	●
Fuel filler pump	●

Hydraulic

Electronic Power Optimizing System (EPOS)	■
Variable axial piston main pump (tandem)	■
Cross-sensing pump control	■
Pilot-operated control valves	■
Gear pilot pump	■
D-ECOPOWER	■
Smart Power Control (SPC)	■
Axial piston swing motor	■
Spring-applied hydraulic release brake, swing motor	■
Axial piston travel motor (high/low, auto)	■
Auxiliary hydraulics, one- & two-way piping	■
Auxiliary hydraulics, tilt/rotate piping	■
Adjustable auxiliary flow & pressure, 10 presets	■
Intelligent floating boom	●
Breaker filter	●
Boom & arm lock valves	●
Straight travel	●

Controls

Joystick controls	■
Pattern control change valve (SAE, ISO)	■
Joystick attachment control	■
Switches/buttons	■
- Right (one-way, two-way, power boost)	■
- Left (tilt/rotate, horn, one-touch decel)	■
Foot pedal attachment control	■
Control stands	■
- Height adjustable	■
- Sliding (fore/aft)	■
- Tilting armrests	■
Engine speed control dial	■
Travel pedals with hand levers	■
Straight travel pedal	●
Switches, console-mounted	■
- Starter button switch	■
- Travel speed selector	■
- Work light	■
- Auxiliary mode switch	■
Emergency stop switch	■
Power modes (P+, P, S, E)	■
Work modes (digging, lifting, breaker, shear)	■
Smart Power Control (SPC)	■
Jog dial display control	■
Bluetooth® control panel	■
Wiper control panel	■
Audio control panel	■

Cabin

Steel, all-weather & sound-suppressed	■
ROPS (ISO 12117-2:2008)	■
Viscous mount with spring reinforcement	■
Front window with wiper/washer	■
Tinted safety glass	■
Skylight top hatch with sun screen	■
Front window with sun screen	■
Pull-up type top front window	■
Removable lower front window with storage behind seat	■
Adjustable sliding side door window	■
Defrost, front window	■
Lockable doors	■
Seat	■
- Heated	■
- Air suspension	■
- 2" (51 mm) seat belt	■
- Adjustable height & recline	■
- Adjustable fore/aft	■
- Adjustable armrests	■
Leatherette seat	■
- Heating & cooling	■
- Air suspension	■
- 2" (51 mm) seat belt	●
- Adjustable height & recline	●
- Adjustable fore/aft	●
- Adjustable armrests	●
3" (76 mm) seat belt	●
Control stands	■
- Height adjustable	■
- Mounted to seat base	■
Storage for operator's manuals	■
Mirrors	■
Fully automatic HVAC with ambient temperature sensor	■
8" multi-function LCD interactive display monitor	■
Cigarette lighter	■
Digital Bluetooth audio broadcasting MP3 radio with cell phone integration	■
Speakers (2)	■
Antenna, roof-mounted	■
Emergency breakout tool	■
Hot/cold beverage compartment	■
Power socket, 12 V & 24 V	■
Cup holder	■
Interior light	■
Coat hanger	■
Rain shield	●
Fog guard	●
Panto wiper, front windshield & lower window	■
Front window guard	●
Vandalism window cover mount	■

Electrical

System voltage – 24 V	■
Alternator – 28 V, 100 amp	■
2 x 12 V batteries, 200 AH reserve capacity	■
Blade-type fuse panel	■
Main circuit breaker	■
Light, work (LED): machine (2), boom (2)	■
Light, work (LED): 6 cab top, front (4), rear (2)	●
Light, work (LED): 4 cab top, front (2), rear (2)	●
Rotating beacon	●
Hour meter	■
Engine restart prevention system	■
Side view camera with LED lamps (3)	●
Rearview camera with LED lamps (3)	■
360° all-around view camera	●
Ultrasonic sensor	●
Laptop service port	■
Self-diagnostics system	■
Smart key (remote ignition key)	■
DEVELON Fleet Management	■

Display Monitor & Warnings

Indicators	■
- Work modes (P+, P, S, E)	■
- User/Service menu	■
Gauges	■
- Fuel level	■
- DEF level	■
- Engine coolant temperature	■
- Hydraulic oil temperature	■
- Engine rpm	■
- Battery voltage	■
- Hydraulic pump pressure	■
- ECO	■
- Digital clock	■
- Trip meter	■
- Hour meter	■
- Fuel consumption	■
Warning & indicator lights	■
- Seat belt	■
- Error code	■
- SCR warning	■
- Check engine	■
- Engine oil pressure	■
- Engine pre-heat engaged	■
- Radiator coolant level & temperature	■
- Air filter	■
- Fuel level	■
- DEF level – low	■
- Water in fuel	■
- Battery charge	■
- Work lights on	■
- Hydraulic oil temperature	■
- Hydraulic charge pressure	■
- Hydraulic pilot filter	■
- Hydraulic return filter	■
Swing alarm	■
Travel alarm	■
Buzzer	■
- Engine oil pressure	■
- Coolant temperature	■

Undercarriage

Fixed track width	■
Track guards & chains with adjusters	■
Track rollers, upper	2
Track rollers, lower	9
In-shoe motor protection	■
Shoes, double grouser – 600 mm	●
Shoes, triple grouser – 600 mm	●
Shoes, triple grouser – 750 mm	●
Shoes, triple grouser – 800 mm	●
Shoes, triple grouser – 900 mm	■

Frame

Counterweight, fixed	■
Catwalks	●

Other

Centralized lubrication	■
- Boom	■
- Arm	■
- Swing	■
Handrails & service platforms	■
Skid-resistant steps & service platforms	■
Manuals	■
- Operation & Maintenance	■
- Parts	■
- AEM Safety Manual	■
DEVELON Fleet Management 3-year subscription	■
Vandalism protection	■
- Lockable panels	■
- Lockable fluid fill points	■
- Anti-theft protection (password)	■
- Vandalism window cover mount	■
Air compressor	●

DEVELON

na.develon-ce.com/dx420lc-7

DX420LC-7 Crawler Excavator Spec Sheet

Printed in the U.S.A.

23906_001_D062123

©2023 HD Hyundai Infracore. All rights reserved.
DEVELON is a brand of HD Hyundai Infracore;
HD Hyundai Infracore is an affiliate of HD Hyundai.