

# DEVELON

## Crawler Excavator

# DX350LCR-7



### Engine

Make	DEVELON
Model	DL08
Number of cylinders	6
Rated power, gross (hp per SAE J1995)	271 hp (202 kW) @ 1800 rpm
Rated power, net (hp per SAE J1349)	271 hp (202 kW) @ 1800 rpm
Max. torque, net (SAE J1995)	940 lbf.ft. (1275 Nm) @ 1300 rpm
Displacement	466 in. <sup>3</sup> (7.6 L)
Bore and stroke	4.3 in. x 5.5 in. (108 mm x 139 mm)
Starter	24 V, 8.0 hp (6.0 kW)
Battery	2 x 12 V, 150 AH, 1300 CCA
Alternator	24 V, 100 amp
Air cleaner	Double elements

### Hydraulics

Main pumps	2 x 76 gpm (2 x 288 L/min.)
Pilot pump (gear design)	7.1 gpm (27 L/min.)
Relief pressure (normal mode)	4980 psi (350 kg/cm <sup>2</sup> )
Relief pressure (power boost)	5260 psi (370 kg/cm <sup>2</sup> )

### Working Pressure

Boom/arm/bucket (normal mode)	4980 psi (350 kg/cm <sup>2</sup> )
Boom/arm/bucket (power boost)	5260 psi (370 kg/cm <sup>2</sup> )
Travel	4980 psi (350 kg/cm <sup>2</sup> )
Swing	3700 psi (260 kg/cm <sup>2</sup> )

### Undercarriage

Upper rollers (each track)	2
Lower rollers (each track)	9
Number of shoes (links per side)	48
Total length of track	16' 3" (4960 mm)

### Swing Mechanism

Swing speed	0 – 9.8 rpm
Swing torque	90348 lbf.ft. (12491 kgf-m)

### Drive System

Travel speed (low – high)	2.0 – 3.2 mph (3.2 – 5.2 km/h)
Traction force, max. (drawbar pull)	83335 lbf.ft. (37800 kgf-m)
Max. grade (limited by engine lub)	70% (35°)

### Environment

Sound level (2000/14/EC)	103 dB(A)
Cabin sound level (ISO 6396)	69 dB(A)

### Refill Capacities

Fuel tank	129.4 gal. (490 L)
DEF tank	16.4 gal. (62 L)
Cooling system (radiator capacity)	12.5 gal. (47.5 L)
Engine oil (with filler)	11.1 gal. (42 L)
Swing drive	1.8 gal. (7 L)
Final drive (each side)	1.8 gal. (7 L)
Hydraulic system	112.3 gal. (425 L)
Hydraulic tank	46.2 gal. (175 L)

### Hydraulic Cylinders

Boom <sup>1</sup> (2) bore x rod diameter x stroke	Mono boom	5.5 in. x 3.9 in. x 60.2 in. (140 mm x 100 mm x 1530 mm)
	2-PC boom (lower)	5.5 in. x 3.7 in. x 55.1 in. (140 mm x 95 mm x 1400 mm)
	2-PC boom (upper)	6.7 in. x 4.5 in. x 52.8 in. (170 mm x 115 mm x 1341 mm)
Arm <sup>1,2</sup> (1) bore x rod diameter x stroke		6.3 in. x 4.3 in. x 65.4 in. (160 mm x 110 mm x 1660 mm)
Bucket <sup>1</sup> (1) bore x rod diameter x stroke	STD	5.5 in. x 3.5 in. x 45.3 in. (140 mm x 90 mm x 1150 mm)
	SLR	–

<sup>1</sup> Cushion on rod end

<sup>2</sup> Cushion on base end

The piston rods and cylinder bodies are made of high-strength steel. A shock-absorbing mechanism is fitted in all cylinders to ensure shock-free operation and extended piston life.

NOTE: Where applicable, dimensions are in accordance with Society of Automotive Engineers (SAE) and ISO standards. Specifications and design are subject to change without notice. All dimensions are given for DEVELON excavators equipped with standard tracks and the standard front as listed. Pictures of DEVELON excavators may show other than standard equipment. All dimensions are shown in inches. Respective metric dimensions are enclosed by parentheses. Rounding may impact specifications. DEVELON equipment is manufactured with a Quality Management System that is in compliance with ISO 9001:2008.

# Dimensions

	Mono Boom & Standard Arm 34" (850 mm) TG Shoe (US20)		2-PC & Standard Arm 34" (850 mm) TG Shoe (US45)	
Boom length	20' 6" (6245 mm)			
Arm length	10' 2" (3100 mm)			
Bucket type (SAE)	1.66 yd <sup>3</sup> (1.27 m <sup>3</sup> )			
Track type	Fixed			
Tail swing radius	A <sub>1</sub>	6' 3" (1900 mm)		
Tail swing overhang (rear)	A <sub>2</sub>	-1' 11" (-580 mm)		
Tail swing overhang (side)	A <sub>3</sub>	4" (100 mm)		
Shipping height (boom)	B	11' 3" (3425 mm)	11' 7" (3525 mm)	
Shipping height (hose)	C	11' 8" (3550 mm)	-	
Shipping length	D	32' 9" (9975 mm)	35' 3" (10740 mm)	
Shipping width	E	11' 10" (3600 mm)		
Counterweight clearance*	F	3' 8" (1130 mm)		
Cabin height	G	10' 6" (3200 mm)		
Upper structure width	H	9' 10" (2990 mm)		
Cabin height above house	I	2' 4" (365 mm)		
Cabin width	J	3' 4" (1010 mm)		
Tumbler distance	K	13' 3" (4040 mm)		
Overall track length	L	16' 3" (4960 mm)		
Undercarriage width	M	11' 10" (3600 mm)		
Track gauge	N	9' 0" (2570 mm)		
Track shoe width	O	34" (850 mm)		
Track height*	P	3' 2" (970 mm)		
Car body clearance*	Q	1' 6" (475 mm)		

\*Without shoe grouser height (30 mm)

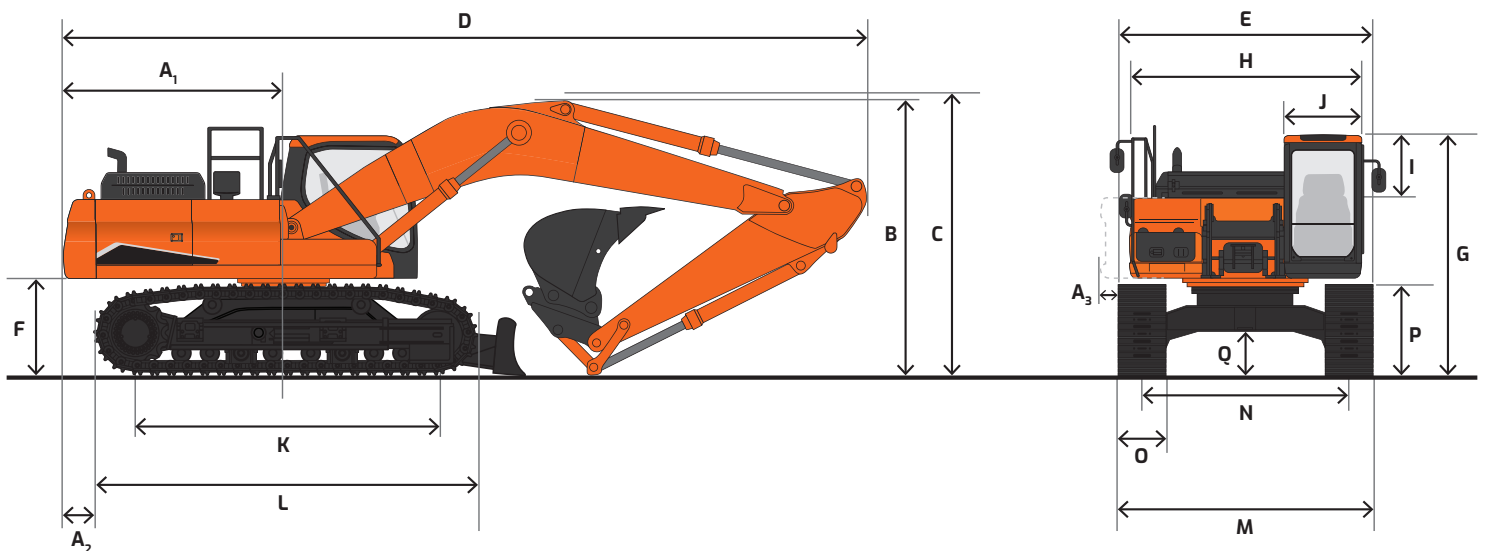

# Working Range

		<b>Mono Boom &amp; Standard Arm</b> 34" (850 mm) TG Shoe (US20)	<b>2-PC &amp; Standard Arm</b> 34" (850 mm) TG Shoe (US45)
Boom length		20' 6" (6245 mm)	20' 6" (6255 mm)
Arm length		10' 2" (3100 mm)	
Bucket type (SAE, PCSA)		1.66 yd. <sup>3</sup> (1.27 m <sup>3</sup> )	
Counterweight		16976 lb. (7700 kg)	11244 lb. (5100 kg)
Track type		Fixed	
Max. digging reach	A	35' 6" (10820 mm)	35' 11" (10940 mm)
Max. digging reach (ground)	B	34' 10" (10620 mm)	35' 3" (10740 mm)
Max. digging depth	C	22' 10" (6970 mm)	22' 1" (6725 mm)
Max. loading height	D	26' 6" (8065 mm)	28' 3" (8615 mm)
Min. loading height	E	10' 4" (3155 mm)	11' 1" (3385 mm)
Max. digging height	F	36' 9" (11200 mm)	38' 9" (11805 mm)
Max. bucket pin height	G	31' 9" (9665 mm)	33' 6" (10215 mm)
Max. vertical wall depth	H	20' 2" (6154 mm)	18' 3" (5560 mm)
Max. radius vertical	I	22' 6" (6850 mm)	23' 1" (7030 mm)
Max. depth to 8' line	J	22' 4" (6795 mm)	21' 9" (6620 mm)
Min. radius to 8' line	K	11' 4" (3450 mm)	6' 7" (2000 mm)
Min. digging reach	L	2' 4" (725 mm)	-4' 1" (-1235 mm)
Min. swing radius	M	10' 5" (3175 mm)	10' 7" (3235 mm)
Bucket angle (DEG)	d	175°	175°
Digging force, bucket (PCSA)*	ISO	47400 lbf. (21500 kgf)	
Digging force, arm*		35055 lbf. (15900 kgf)	
Operating weight		79702 lb. (36152 kg)	80929 lb. (36709 kg)
Ground pressure		7.0 psi (0.48 kg/cm <sup>2</sup> )	7.1 psi (0.49 kg/cm <sup>2</sup> )

\*With power boost ON

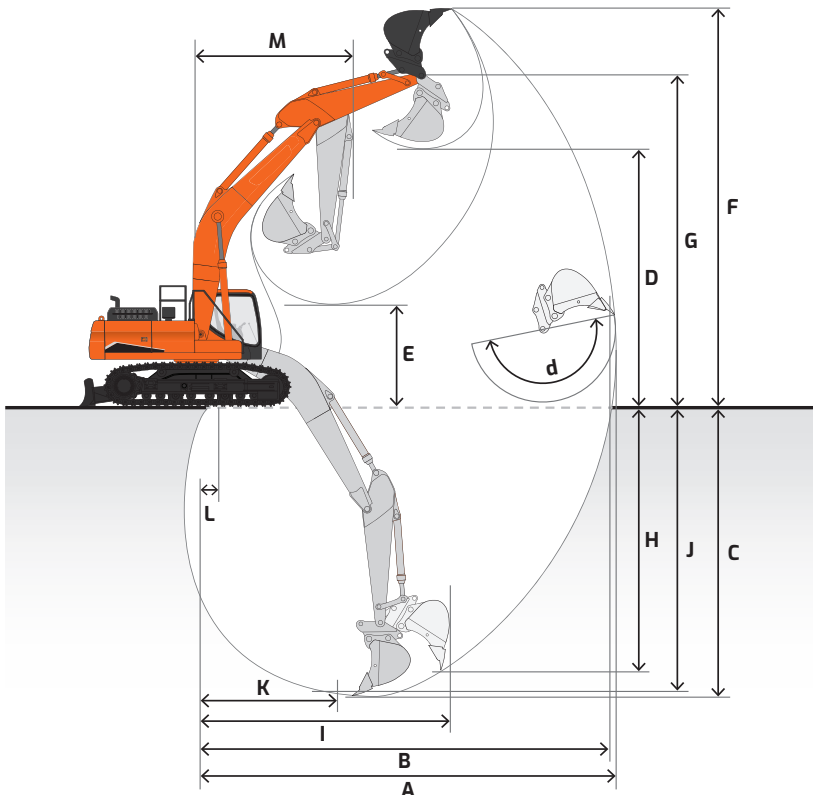















# Lifting Capacity

 Rating over front     Rating over side or 360°

## DX350LCR-7 US20

Boom: 20' 6" (6245 mm) | Arm: 10' 2" (3100 mm) | Counterweight: 16976 lb. (7700 kg) | 34" (850 mm) TG Shoes | Bucket: None | Unit: lb. (kg)

A (ft. or m) B (ft. or m)	5' (1.5 m)		10' (3.0 m)		15' (4.5 m)		20' (6.0 m)		25' (7.5 m)		30' (9.0 m)		Max. Reach		
															A
30' (9.0 m)													* 14240 (* 6460)	* 14240 (* 6460)	19.5' (5.94 m)
25' (7.5 m)							* 18330 (* 8310)	* 18330 (* 8310)					* 12840 (* 5830)	* 12840 (* 5830)	24.21' (7.38 m)
20' (6.0 m)							* 19400 (* 8800)	* 19400 (* 8800)	* 17950 (* 8140)	13640 (6190)			* 12370 (* 5610)	11390 (5160)	27.22' (8.3 m)
15' (4.5 m)			* 40260 (* 18260)	* 40260 (* 18260)	* 27140 (* 12310)	* 27140 (* 12310)	* 21780 (* 9880)	18860 (8560)	* 18930 (* 8590)	13230 (6000)			* 12410 (* 5630)	9960 (4520)	29.09' (8.87 m)
10' (3.0 m)					* 33420 (* 15160)	27260 (12360)	* 24670 (* 11190)	17740 (8050)	19850 (9000)	12680 (5750)	14870 (6750)	9500 (4310)	* 12880 (* 5840)	9230 (4190)	30.03' (9.15 m)
5' (1.5 m)					* 37600 (* 17060)	25320 (11490)	* 27050 (* 12270)	16740 (7590)	19260 (8730)	12140 (5510)	14610 (6630)	9250 (4200)	* 13820 (* 6270)	8970 (4070)	30.13' (9.18 m)
Ground Level					* 38310 (* 17380)	24460 (11100)	26420 (11980)	16080 (7300)	18820 (8540)	11750 (5330)			14520 (6590)	9140 (4150)	29.39' (8.96 m)
-5' (-1.5 m)			* 30230 (* 13710)	* 30230 (* 13710)	* 36430 (* 16530)	24280 (11010)	26110 (11840)	15820 (7170)	18640 (8450)	11580 (5250)			15710 (7120)	9850 (4470)	27.77' (8.46 m)
-10' (-3.0 m)			* 42500 (* 19280)	* 42500 (* 19280)	* 32260 (* 14630)	24530 (11130)	* 24680 (* 11200)	15900 (7210)	* 18400 (* 8350)	11730 (5320)			* 17730 (* 8040)	11470 (5200)	25.05' (7.63 m)
-15' (-4.5 m)			* 31600 (* 14340)	* 31600 (* 14340)	* 24840 (* 11270)	* 24840 (* 11270)	* 18320 (* 8310)	16450 (7460)					* 16450 (* 7460)	15260 (6920)	20.83' (6.35 m)

A Distance from center of rotation  
B Height

NOTE: Lifting capacities are in compliance with SAE 1097 and ISO 10567. Machine in lifting mode with power boost turned on. Load point is the end of the arm. Rated loads shown do not exceed 75% of minimum tipping loads or 87% of hydraulic capacities. Rated loads marked with an asterisk (\*) are limited by hydraulic capacities. The least stable position is over the side. The total mass of machine includes the mass of the boom, arm, counterweight, all operating fluids and 165 lb. (75 kg) operator.

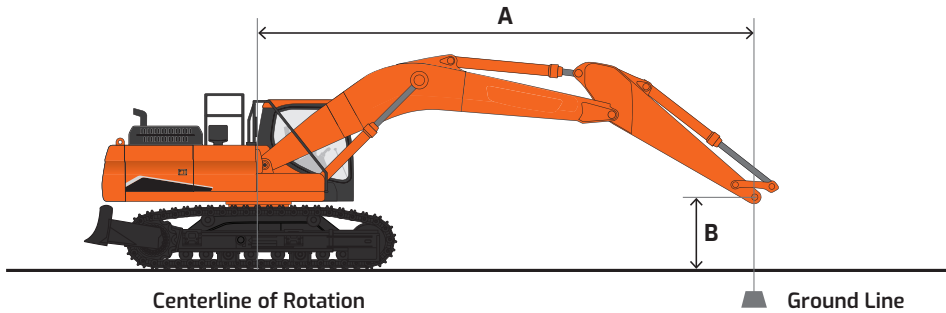















# Lifting Capacity

 Rating over front     Rating over side or 360°

## DX350LCR-7 US45

Boom: 20' 6" (6245 mm) | Arm: 12' 4" (3750 mm) | Counterweight: 11244 lb. (5100 kg) | 34" (850 mm) TG Shoes | Bucket: None | Unit: lb. (kg)

A (ft. or m) B (ft. or m)	5' (1.5 m)		10' (3.0 m)		15' (4.5 m)		20' (6.0 m)		25' (7.5 m)		30' (9.0 m)		Max. Reach		
															A
30' (9.0 m)													* 11530 (* 5230)	* 11530 (* 5230)	22.10' (6.74 m)
25' (7.5 m)									* 13910 (* 6310)	* 13910 (* 6310)			* 10650 (* 4830)	* 10650 (* 4830)	26.33' (8.03 m)
20' (6.0 m)							* 17450 (* 7920)	* 17450 (* 7920)	* 16430 (* 7450)	13910 (6310)			* 10370 (* 4700)	10260 (4660)	29.13' (8.88 m)
15' (4.5 m)					* 23970 (* 10870)	* 23970 (* 10870)	* 19930 (* 9040)	19270 (8740)	* 17620 (* 7990)	13440 (6090)	* 14250 (* 6460)	9860 (4470)	* 10460 (* 4740)	9080 (4120)	30.87' (9.41 m)
10' (3.0 m)					* 30500 (* 13840)	28150 (12770)	* 23060 (* 10460)	18070 (8200)	* 19220 (* 8720)	12820 (5810)	14960 (6790)	9560 (4340)	* 10880 (* 4940)	8440 (3830)	31.76' (9.68 m)
5' (1.5 m)					* 35830 (* 16250)	25820 (11710)	* 25890 (* 11740)	16930 (7680)	19340 (8770)	12200 (5530)	14610 (6630)	9230 (4190)	* 11680 (* 5300)	8180 (3710)	31.85' (9.71 m)
Ground Level			* 20640 (* 9360)	* 20640 (* 9360)	* 38040 (* 17260)	24520 (11120)	26460 (12000)	16100 (7300)	18790 (8520)	11700 (5310)	14330 (6500)	8970 (4070)	* 12990 (* 5890)	8290 (3760)	31.16' (9.50 m)
-5' (-1.5 m)	* 21360 (* 9690)	* 21360 (* 9690)	* 30080 (* 13650)	* 30080 (* 13650)	* 37400 (* 16970)	24040 (10900)	25970 (11780)	15660 (7110)	18480 (8380)	11420 (5180)	14210 (6440)	8860 (4020)	14140 (6410)	8820 (4000)	29.64' (9.03 m)
-10' (-3.0 m)	* 31470 (* 14270)	* 31470 (* 14270)	* 42430 (* 19240)	* 42430 (* 19240)	* 34370 (* 15590)	24090 (10930)	25890 (11750)	15600 (7080)	18460 (8370)	11400 (5170)			16110 (7310)	10030 (4550)	27.11' (8.26 m)
-15' (-4.5 m)			* 38290 (* 17370)	* 38290 (* 17370)	* 28530 (* 12940)	24590 (11150)	* 21530 (* 9770)	15920 (7220)					* 16740 (* 7590)	12650 (5740)	23.29' (7.10 m)
-20' (-6.0 m)					* 17670 (* 8020)	* 17670 (* 8020)							* 15300 (* 6940)	* 15300 (* 6940)	16.65' (5.07 m)

A Distance from center of rotation  
B Height

NOTE: Lifting capacities are in compliance with SAE 1097 and ISO 10567. Machine in lifting mode with power boost turned on. Load point is the end of the arm. Rated loads shown do not exceed 75% of minimum tipping loads or 87% of hydraulic capacities. Rated loads marked with an asterisk (\*) are limited by hydraulic capacities. The least stable position is over the side. The total mass of machine includes the mass of the boom, arm, counterweight, all operating fluids and 165 lb. (75 kg) operator.

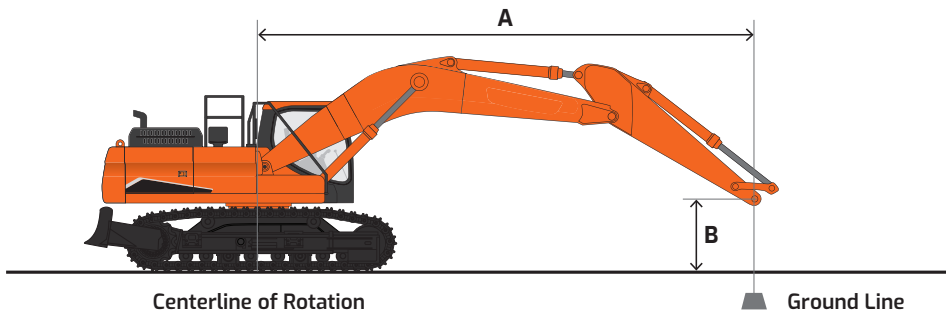















# Lifting Capacity

 Rating over front     Rating over side or 360°

## DX350LCR-7 US45

2-PC Boom: 20' 6" (6245 mm) | Arm: 10' 2" (3100 mm) | Counterweight: 11244 lb. (5100 kg) | 34" (850 mm) Shoes | With Dozer Up | Bucket: None | Unit: lb. (kg)

A (ft. or m) B (ft. or m)	5' (1.5 m)		10' (3.0 m)		15' (4.5 m)		20' (6.0 m)		25' (7.5 m)		30' (9.0 m)		Max. Reach		
															A
30' (9.0 m)							* 17470 (* 7930)	* 17470 (* 7930)					* 15600 (* 7080)	* 15600 (* 7080)	20.17' (5.94 m)
25' (7.5 m)							* 21070 (* 9560)	18650 (8460)	* 14640 (* 6640)	12390 (5620)			* 13860 (* 6290)	12220 (5540)	24.77' (7.38 m)
20' (6.0 m)							* 21900 (* 9930)	18160 (8240)	17910 (8120)	12390 (5620)			* 13160 (* 5970)	9900 (4490)	27.71' (8.3 m)
15' (4.5 m)					* 32800 (* 14880)	27400 (12430)	* 24130 (* 10950)	17210 (7810)	17450 (7920)	11970 (5430)	12720 (5770)	8680 (3940)	12700 (5760)	8660 (3930)	29.55' (8.87 m)
10' (3.0 m)					* 37090 (* 16820)	24740 (11220)	24150 (10960)	16050 (7280)	16830 (7640)	11410 (5180)	12510 (5680)	8480 (3850)	11860 (5380)	8020 (3640)	30.48' (9.15 m)
5' (1.5 m)					37270 (16910)	22790 (10340)	23010 (10440)	15040 (6820)	16240 (7370)	10870 (4930)	12260 (5560)	8250 (3740)	11610 (5270)	7810 (3540)	30.57' (9.18 m)
Ground Level					36110 (16380)	21980 (9970)	22290 (10110)	14410 (6540)	15830 (7180)	10500 (4760)	12100 (5490)	8100 (3670)	11910 (5400)	7980 (3620)	29.86' (8.96 m)
-5' (-1.5 m)		* 27280 (* 12380)	* 27280 (* 12380)		31070 (14090)	21880 (9930)	22030 (9990)	14190 (6440)	15680 (7110)	10360 (4700)			12920 (5860)	8640 (3920)	28.25' (8.46 m)
-10' (-3.0 m)					* 23450 (10640)	22230 (10080)	* 18990 (* 8610)	14340 (6500)	* 13250 (* 6010)	10570 (4790)			* 11430 (* 5180)	10080 (4570)	25.6' (7.63 m)

A Distance from center of rotation  
B Height

NOTE: Lifting capacities are in compliance with SAE 1097 and ISO 10567. Machine in lifting mode with power boost turned on. Load point is the end of the arm. Rated loads shown do not exceed 75% of minimum tipping loads or 87% of hydraulic capacities. Rated loads marked with an asterisk (\*) are limited by hydraulic capacities. The least stable position is over the side. The total mass of machine includes the mass of the boom, arm, counterweight, all operating fluids and 165 lb. (75 kg) operator.

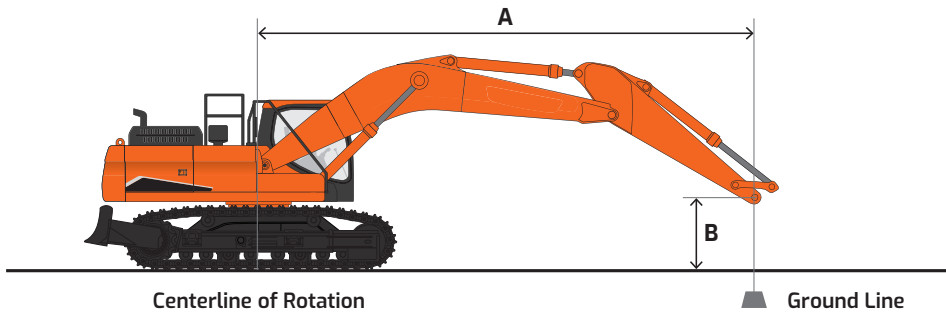

# Standard & Optional Equipment

■ Standard    ● Optional

## Engine

Emissions (EPA)	T4f
High-pressure common-rail (HPCR)	■
Variable geometry (VGT)	■
Cooled exhaust gas recirculation (CEGR)	■
Selective catalyst reduction (SCR)	■
Diesel exhaust fluid (DEF)	■
Fuel filter with water separator	■
Coolant expansion tank	■
Dual element dry-type air filter with evacuator	■
Electronic engine control (ECU)	■
Auto idle	■
Auto shutdown (time-adjustable)	■
Overheat & low oil pressure engine protection	■
Block heater (110 V)	●
Fuel filler pump	●

## Hydraulic

Electronic Power Optimizing System (EPOS)	■
Variable axial piston main pump (tandem)	■
Cross-sensing pump control	■
Pilot-operated control valves	■
Gear pilot pump	■
Smart Power Control (SPC)	■
Axial piston swing motor	■
Spring-applied hydraulic release brake, swing motor	■
Axial piston travel motor (high/low, auto)	■
Auxiliary hydraulics, one- & two-way piping	■
Auxiliary hydraulics, tilt/rotate piping	■
Adjustable auxiliary flow & pressure, 10 presets	■
Breaker filter	●
Boom & arm lock valves	●
Straight travel	●

## Controls

Joystick controls	■
Pattern control change valve (SAE, ISO)	■
Joystick attachment control	■
Switches/buttons	■
- Right (one-way, two-way, power boost)	■
- Left (tilt/rotate, horn, one-touch decel)	■
Foot pedal attachment control	■
Control stands	■
- Height adjustable	■
- Sliding (fore/aft)	■
- Tilting armrests	■
Engine speed control dial	■
Travel pedals with hand levers	■
Straight travel pedal	●
Switches, console-mounted	■
- Starter button switch	■
- Travel speed selector	■
- Work light	■
- Auxiliary mode switch	■
Emergency stop switch	■
Power modes (P+, P, S, E)	■
Work modes (digging, lifting, breaker, shear)	■
Smart Power Control (SPC)	■
Jog dial display control	■
Bluetooth® control panel	■
Wiper control panel	■
Audio control panel	■

## Cabin

Steel, all-weather & sound-suppressed	■
ROPS (ISO 12117-2:2008)	■
Viscous mount with spring reinforcement	■
Front window with wiper/washer	■
Tinted safety glass	■
Skylight top hatch with sun screen	■
Front window with sun screen	■
Pull-up type top front window	■
Removable lower front window with storage behind seat	■
Adjustable sliding side door window	■
Defrost, front window	■
Lockable doors	■
Seat	■
- Heated	■
- Air suspension	■
- 2" (51 mm) seat belt	■
- Adjustable height & recline	■
- Adjustable fore/aft	■
- Adjustable armrests	■
Leatherette seat	■
- Heating & cooling	■
- Air suspension	■
- 2" (51 mm) seat belt	●
- Adjustable height & recline	●
- Adjustable fore/aft	●
- Adjustable armrests	●
3" (76 mm) seat belt	●
Control stands	■
- Height adjustable	■
- Mounted to seat base	■
Storage for operator's manuals	■
Mirrors	■
Fully automatic HVAC with ambient temperature sensor	■
8" multi-function LCD interactive display monitor	■
Cigarette lighter	■
Digital Bluetooth audio broadcasting MP3 radio with cell phone integration	■
Speakers (2)	■
Antenna, roof-mounted	■
Emergency breakout tool	■
Hot/cold beverage compartment	■
Power socket, 12 V & 24 V	■
Cup holder	■
Interior light	■
Coat hanger	■
Rain shield	●
Fog guard	●
Panto wiper, front windshield & lower window	■
Front window guard	●
Vandalism window cover mount	■

## Electrical

System voltage – 24 V	■
Alternator – 24 V, 80 amp	■
2 x 12 V batteries, 150 AH reserve capacity	■
Blade-type fuse panel	■
Main circuit breaker	■
Light, work (LED): machine (2), boom (2)	■
Light, work (LED): 6 cab top, front (4), rear (2)	●
Light, work (LED): 4 cab top, front (2), rear (2)	●
Rotating beacon	●
Hour meter	■
Engine restart prevention system	■
Side view & rearview camera with LED lamps (6)	■
360° all-around view camera	●
Ultrasonic sensor	●
Laptop service port	■
Self-diagnostics system	■
Smart key (remote ignition key)	■
DEVELON Fleet Management	■

## Display Monitor & Warnings

Indicators	■
- Work modes (P+, P, S, E)	■
- User/Service menu	■
Gauges	■
- Fuel level	■
- DEF level	■
- Engine coolant temperature	■
- Hydraulic oil temperature	■
- Engine rpm	■
- Battery voltage	■
- Hydraulic pump pressure	■
- ECO	■
- Digital clock	■
- Trip meter	■
- Hour meter	■
- Fuel consumption	■
Warning & indicator lights	■
- Seat belt	■
- Error code	■
- SCR warning	■
- Check engine	■
- Engine oil pressure	■
- Engine pre-heat engaged	■
- Radiator coolant level & temperature	■
- Air filter	■
- Fuel level	■
- DEF level – low	■
- Water in fuel	■
- Battery charge	■
- Work lights on	■
- Hydraulic oil temperature	■
- Hydraulic charge pressure	■
- Hydraulic pilot filter	■
- Hydraulic return filter	■
Swing alarm	■
Travel alarm	■
Buzzer	■
- Engine oil pressure	■
- Coolant temperature	■

## Undercarriage

Fixed track width	■
Track guards & chains with adjusters	■
Track rollers, upper	2
Track rollers, lower	9
In-shoe motor protection	■
Shoes, triple grouser – 700 mm	●
Shoes, triple grouser – 800 mm	●
Shoes, triple grouser – 850 mm	■

## Frame

Counterweight, fixed	■
----------------------	---

## Other

Centralized lubrication	■
- Boom	■
- Arm	■
- Swing	■
Handrails & service platforms	■
Skid-resistant steps & service platforms	■
Manuals	■
- Operation & Maintenance	■
- Parts	■
- AEM Safety Manual	■
DEVELON Fleet Management 3-year subscription	■
Vandalism protection	■
- Lockable panels	■
- Lockable fluid fill points	■
- Anti-theft protection (password)	■
- Vandalism window cover mount	■
Air compressor	●

Certain specification(s) are based on engineering calculations and are not actual measurements. Specification(s) are provided for comparison purposes only and are subject to change without notice. Specification(s) for your individual DEVELON equipment will vary based on normal variations in design, manufacturing, operating conditions, and other factors. Pictures of DEVELON units may show other than standard equipment.

# Powered by Innovation

# DEVELON

A brand of HD Hyundai Infracore.

[na.develon-ce.com/dx350lcr-7](http://na.develon-ce.com/dx350lcr-7)

DX350LCR-7 Crawler Excavator Spec Sheet  
Printed in the U.S.A.  
23906\_002\_D0102023

©2023 HD Hyundai Infracore. All rights reserved.