

# DEVELON

## Crawler Excavator

# DX140LCR-7



### Engine

Make	DEVELON
Model	G5 D34
Number of cylinders	4
Rated power, gross (hp per SAE J1995)	115.3 hp (86 kW) @ 2000 rpm
Rated power, net (hp per SAE J1349)	100.6 hp (86 kW) @ 2000 rpm
Max. torque, net (SAE J1995)	339 lb.-ft. (460 Nm) @ 1400 rpm
Displacement	208 in. <sup>3</sup> (3.4 L)
Bore and stroke	3.9 in. x 4.4 in. (98 mm x 113 mm)
Starter	24 V, 6.7 hp (5.0 kW)
Battery	2 x 12 V, 100 AH
Alternator	24 V, 100 amp
Air cleaner	Two-stage

### Hydraulics

Main pumps	2 x 30.12 gpm (2 x 114 L/min.)
Pilot pump (gear design)	8 gpm (30 L/min.)

### Working Pressure

Boom/arm/bucket (normal mode)	4786 psi (336 kg/cm <sup>2</sup> )
Boom/arm/bucket (power boost)	5076 psi (356 kg/cm <sup>2</sup> )
Travel	5076 psi (356 kg/cm <sup>2</sup> )
Swing	3916 psi (275 kg/cm <sup>2</sup> )
Pilot	566 psi (40 kg/cm <sup>2</sup> )

### Undercarriage

Upper rollers (each track)	1
Lower rollers (each track)	7
Number of shoes (links per side)	46

### Swing Mechanism

Swing speed	0 – 10.1 rpm
Swing torque	35355 lb.-ft. (4888 kgf-m)

### Drive System

Travel speed (low – high)	1.68 – 2.86 mph (2.7 – 4.6 km/h)
Traction force, max. (drawbar pull)	33510 lb.-ft. (15200 kgf-m)
Max. grade (limited by engine lub)	70% (35°)

### Environment

Sound level (2000/14/EC)	98 dB(A)
Cabin sound level (ISO 6396)	72 dB(A)

### Refill Capacities

Fuel tank	54.9 gal. (208 L)
DEF tank	6.6 gal. (25 L)
Cooling system (radiator capacity)	6.7 gal. (25.5 L)
Engine oil (with filler)	3.3 gal. (12.6 L)
Swing drive	0.8 gal. (3 L)
Final drive (each side)	0.5 gal. (2 L)
Hydraulic system	55.4 gal. (210 L)
Hydraulic tank	33.8 gal. (128 L)

### Hydraulic Cylinders

Boom <sup>1</sup> (2) bore x rod diameter x stroke	4.3 in. x 3.0 in. x 43.4 in. (110 mm x 75 mm x 1103 mm)
Arm <sup>1,2</sup> (1) bore x rod diameter x stroke	4.5 in. x 3.1 in. x 43.6 in. (115 mm x 80 mm x 1108 mm)
Bucket (STD) <sup>1</sup> (1) bore x rod diameter x stroke	3.9 in. x 2.8 in. x 35.4 in. (100 mm x 70 mm x 900 mm)

<sup>1</sup> Cushion on rod end

<sup>2</sup> Cushion on base end

The piston rods and cylinder bodies are made of high-strength steel. A shock-absorbing mechanism is fitted in all cylinders to ensure shock-free operation and extended piston life.

NOTE: Where applicable, dimensions are in accordance with Society of Automotive Engineers (SAE) and ISO standards. Specifications and design are subject to change without notice. All dimensions are given for DEVELON excavators equipped with standard tracks and the standard front as listed. Pictures of DEVELON excavators may show other than standard equipment. All dimensions are shown in inches. Respective metric dimensions are enclosed by parentheses. Rounding may impact specifications. DEVELON equipment is manufactured with a Quality Management System that is in compliance with ISO 9001:2008.

# Dimensions

		Standard Arm 24" (600 mm) TG Shoe (US20)	Standard Arm & Dozer Blade 20" (500 mm) TG Shoe (US30)	24" (600 mm) TG Shoe (US40)	28" (700 mm) TG Shoe (US50)
Boom length		15' 1" (4600 mm)			
Arm length		9' 10" (3000 mm)			
Bucket type (SAE)		0.51 yd <sup>3</sup> (0.39 m <sup>3</sup> )			
Track type		Fixed			
Tail swing radius	A <sub>1</sub>	5' 0" (1524 mm)			
Tail swing overhang (rear)	A <sub>2</sub>	-1' 2" (-353 mm)			
Tail swing overhang (side)	A <sub>3</sub>	9" (230 mm)	11" (280 mm)	9" (230 mm)	7" (180 mm)
Shipping height (boom)*	B	10' 1" (3060 mm)			
Shipping height (hose)*	C	10' 3" (3135 mm)			
Shipping length	D	26' 3" (7990 mm)			
Shipping width	E	8' 5" (2590 mm)	8' 2" (2490 mm)	8' 5" (2590 mm)	8' 10" (2690 mm)
Counterweight clearance*	F	2' 11" (895 mm)			
Cabin height*	G	9' 5" (2874 mm)			
Upper structure width	H	8' 10" (2690mm)			
Cabin height above house*	I	2' 3" (697mm)			
Cabin width	J	3' 4" (1022 mm)			
Tumbler distance	K	9' 11" (3034 mm)			
Overall track length	L	12' 4" (3754 mm)			
Undercarriage width	M	8' 6" (2590 mm)	8' 2" (2490 mm)	8' 6" (2590 mm)	8' 10" (2690 mm)
Track gauge	N	6' 6" (1990 mm)			
Track shoe width	O	24" (600 mm)	20" (500 mm)	24" (600 mm)	28" (700 mm)
Track height	P	2' 5" (743 mm)			
Car body clearance	Q	1' 3" (381.5 mm)			

\*Without shoe grouser

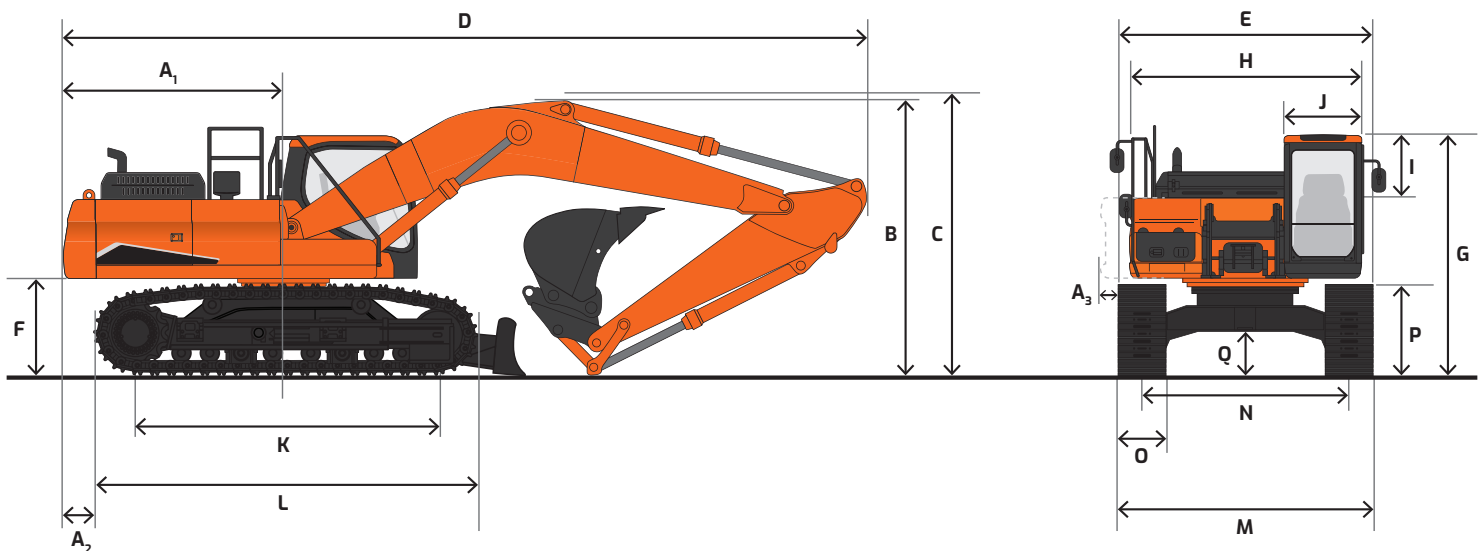

# Working Range

	Standard Arm 24" (600 mm) TG Shoe (US20)		Standard Arm & Dozer Blade 24" (600 mm) TG Shoe (US40)		28" (700 mm) TG Shoe (US50)
	Boom length	15' 1" (4600 mm)			
Arm length	9' 10" (3000 mm)				
Bucket type (SAE, PCSA)	0.51 yd <sup>3</sup> (0.39 m <sup>3</sup> )				
Track type	Fixed				
Max. digging reach	A	28' 5" (8665 mm)			
Max. digging reach (ground)	B	27' 11" (8530 mm)			
Max. digging depth	C	19' 7" (5985 mm)			
Max. loading height	D	23' 2" (7080 mm)			
Min. loading height	E	6' 11" (2120 mm)			
Max. digging height	F	31' 0" (9470 mm)			
Max. bucket pin height	G	27' 2" (8300 mm)			
Max. vertical wall depth	H	15' 4" (4680 mm)			
Max. radius vertical	I	19' 7" (5970 mm)			
Max. depth to 8' line	J	18' 10" (5765 mm)			
Min. radius to 8' line	K	6' 8" (2040 mm)			
Min. digging reach	L	-5" (-130 mm)			
Min. swing radius	M	7' 7" (2320 mm)			
Bucket angle (DEG)	d	174°			
Digging force, bucket (PCSA)	ISO	24471 lbf. (11100 kgf)			
Digging force, arm		13228 lbf. (6000 kgf)			
Operating weight		34017 lb. (15430 kg)	36817 lb. (16700 kg)	36960 lb. (16800 kg)	
Ground pressure		5.83 psi (0.41 kg/cm <sup>2</sup> )	5.97 psi (0.42 kg/cm <sup>2</sup> )	5.26 psi (0.37 kg/cm <sup>2</sup> )	

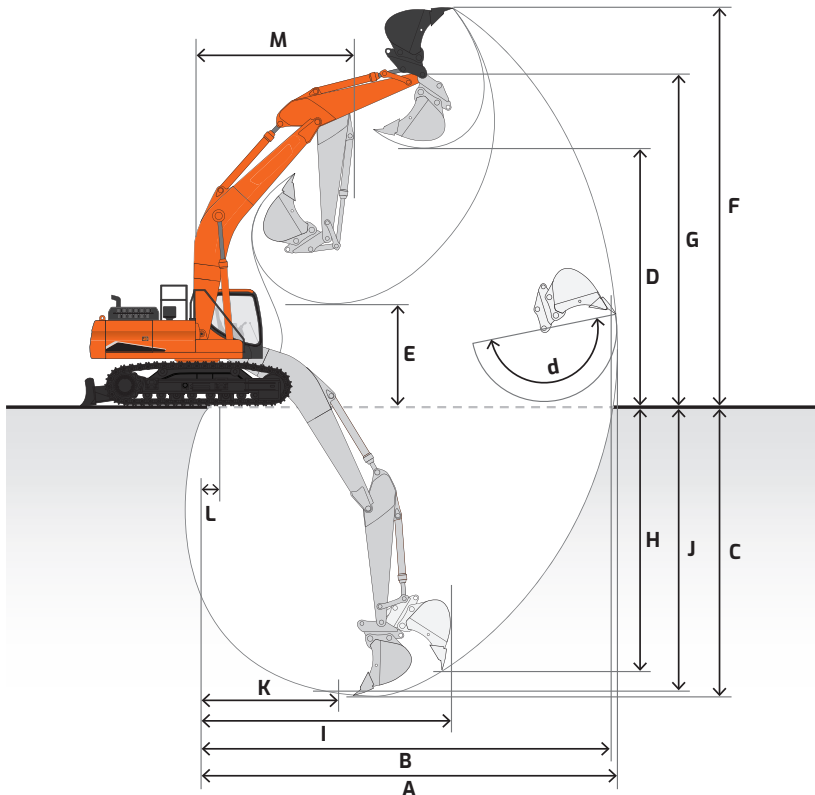

# Bucket

	Standard Arm (U520)	Standard Arm & Dozer Blade (U530)   (U540)   (U550)		
<b>Boom</b>	15' 1" (4600 mm)			
<b>Arm</b>	9' 10" (3000 mm)			
<b>Shoe size</b>	24" (600 mm)	20" (500 mm)	24" (600 mm)	28" (600 mm)
<b>Track type</b>	Fixed		Fixed with dozer	
<b>Mount</b>	Pin-on	Quick-coupler	Pin-on	Quick-coupler
<b>Counterweight</b>	7040 lb. (3200 kg)			

Bucket Type	Model	Capacity* yd <sup>3</sup> (m <sup>3</sup> )	Width in. (mm)	Weight lb. (kg)				
Heavy-duty	HD14-024	0.44 (0.34)	24 (609.6)	901 (409)	A	A	A	A
	HD14-030	0.59 (0.45)	30 (762)	1001 (454)	A	B	A	B
	HD14-036	0.75 (0.57)	36 (914.4)	1129 (512)	B	B	B	C
	HD14-042	0.91 (0.70)	42 (1066.8)	1222 (554)	C	X	C	X
	HD14-048	1.06 (0.81)	48 (1219.2)	1338 (607)	X	X	X	X
Severe-duty	SD14-024	0.44 (0.34)	24 (609.6)	931 (422)	A	A	A	A
	SD14-030	0.59 (0.45)	30 (762)	1035 (469)	A	B	A	B
	SD14-036	0.75 (0.57)	36 (914.4)	1154 (523)	B	C	C	X
	SD14-042	0.91 (0.70)	42 (1066.8)	1248 (566)	C	X	C	X
	SD14-048	1.06 (0.81)	48 (1219.2)	1367 (620)	X	X	X	X
Ditching	DC140-048	0.63 (0.48)	48 (1219.2)	820 (372)	A	B	A	B
	DC140-060	0.80 (0.61)	60 (1524)	985 (447)	B	C	B	C
	HDC140-060	1.38 (1.06)	60 (1524)	1620 (735)	X	X	X	X

\*Capacity based on ISO 7451 and heaped with a 1:1 angle of repose

• Equipped with bolt-on wear shrouds

• Equipped with bolt-on teeth

• Equipped with bolt-on cutting edge

• These recommendations are given as a guide only and based on typical operating conditions.

#### Maximum Suitable Material Density

A 3370 lb./yd<sup>3</sup> (2000 kg/m<sup>3</sup>)

B 2700 lb./yd<sup>3</sup> (1600 kg/m<sup>3</sup>)

C 1850 lb./yd<sup>3</sup> (1100 kg/m<sup>3</sup>)

X Not Approved











Please consult with your DEVELON dealer to properly match buckets and attachments for the application.

# Lifting Capacity

 Rating over front     Rating over side or 360°











## DX140LCR-7 US20

Boom: 15' 1" (4600 mm) | Arm: 9' 10" (3000 mm) | Counterweight: 7040 lb. (3200 kg) | 24" (600 mm) Shoes | No Dozer | Bucket: None | Unit: lb. (kg)

A (ft. or m) B (ft. or m)	5' (1.5 m)		10' (3.0 m)		15' (4.5 m)		20' (6.0 m)		Max. Reach		A
											
25' (7.5 m)									* 5620 (* 2550)	* 5620 (* 2550)	14.00' (4.27 m)
20' (6.0 m)					* 7220 (* 3280)	* 7220 (* 3280)			* 4510 (* 2050)	* 4510 (* 2050)	19.17' (5.91 m)
15' (4.5 m)					* 7850 (* 3560)	* 7850 (* 3560)	* 7070 (* 3210)	5340 -2420	* 4280 (* 1940)	* 4270 (* 1940)	22.37' (6.82 m)
10' (3.0 m)			* 12820 (* 5810)	* 12820 (* 5810)	* 10490 (* 4760)	8070 -3660	8060 -3660	5150 -2340	* 4320 (* 1960)	3720 -1690	23.95' (7.30 m)
5' (1.5 m)			* 20470 (* 9290)	13710 -6220	12210 -5540	7480 -3390	7780 -3530	4900 -2220	* 4590 (* 2080)	3500 -1590	24.44' (7.45 m)
Ground Level			* 18400 (* 8350)	12740 -5780	11680 -5300	7020 -3190	7540 -3420	4680 -2120	* 5170 (* 2350)	3540 -1600	23.91' (7.29 m)
-5' (-1.5 m)	* 11470 (* 5200)	* 11470 (* 5200)	* 22330 (* 10130)	12510 -5670	11430 -5190	6810 -3090	7420 -3370	4570 -2070	* 6240 (* 2830)	3870 -1760	22.28' (6.79 m)
-10' (-3.0 m)	* 18080 (* 8200)	* 18080 (* 8200)	* 21050 (* 9550)	12650 -5740	11470 -5200	6840 -3100			7740 -3510	4780 -2170	19.25' (5.87 m)
-15' (-4.5 m)			* 14540 (* 6600)	13170 -5970					* 9750 (* 4420)	7810 -3540	13.92' (4.24 m)











## DX140LCR-7 US30

Boom: 15' 1" (4600 mm) | Arm: 9' 10" (3000 mm) | Counterweight: 7040 lb. (3200 kg) | 20" (500 mm) Shoes | Dozer Up | Bucket: None | Unit: lb. (kg)

A (ft. or m) B (ft. or m)	5' (1.5 m)		10' (3.0 m)		15' (4.5 m)		20' (6.0 m)		Max. Reach		A
											
25' (7.5 m)									* 5340 (* 2420)	* 5340 (* 2420)	14.24' (4.34 m)
20' (6.0 m)					* 7220 (* 3280)	* 7220 (* 3280)			* 4510 (* 2050)	* 4510 (* 2050)	19.41' (5.91 m)
15' (4.5 m)					* 7850 (* 3560)	* 7850 (* 3560)	* 7070 (* 3210)	5630 -2560	* 4280 (* 1940)	* 4280 (* 1940)	22.37' (6.82 m)
10' (3.0 m)			* 12820 (* 5810)	* 12820 (* 5810)	* 10490 (* 4760)	8500 -3850	* 7910 (* 3590)	5450 -2470	* 4320 (* 1960)	3960 -1790	23.95' (7.30 m)
5' (1.5 m)			* 20470 (* 9290)	14470 -6560	11990 -5440	7910 -3590	7640 -3460	5200 -2360	* 4590 (* 2080)	3730 -1690	24.44' (7.45 m)
Ground Level			* 18400 (* 8350)	13490 -6120	11460 -5200	7450 -3380	7390 -3350	4980 -2260	* 5170 (* 2350)	3770 -1710	23.91' (7.29 m)
-5' (-1.5 m)	* 11470 (* 5200)	* 11470 (* 5200)	* 22330 (* 10130)	13260 -6020	11210 -5090	7240 -3280	7270 -3300	4870 -2210	* 6110 (* 2770)	4130 -1870	22.28' (6.79 m)
-10' (-3.0 m)	* 18080 (* 8200)	* 18080 (* 8200)	* 21050 (* 9550)	13410 -6080	11240 -5100	7260 -3290			* 7590 (* 3440)	5080 -2310	19.25' (5.87 m)
-15' (-4.5 m)			* 14540 (* 6600)	13930 -6320					* 9750 (* 4420)	8270 -3750	13.92' (4.24 m)

## DX140LCR-7 US40

Boom: 15' 1" (4600 mm) | Arm: 9' 10" (3000 mm) | Counterweight: 7040 lb. (3200 kg) | 24" (600 mm) Shoes | Dozer Up | Bucket: None | Unit: lb. (kg)

A (ft. or m) B (ft. or m)	5' (1.5 m)		10' (3.0 m)		15' (4.5 m)		20' (6.0 m)		Max. Reach		A
											
25' (7.5 m)									* 5324 (* 2420)	* 5324 (* 2420)	14.24' (4.34 m)
20' (6.0 m)					* 7216 (* 3280)	* 7216 (* 3280)			* 4510 (* 2050)	* 4510 (* 2050)	19.41' (5.91 m)
15' (4.5 m)					* 7832 (* 3560)	* 7832 (* 3560)	* 7062 (* 3210)	5698 (2590)	* 4268 (* 1940)	* 4268 (* 1940)	22.37' (6.82 m)
10' (3.0 m)			* 12782 (* 5810)	* 12782 (* 5810)	* 10472 (* 4760)	8602 (3910)	* 8030 (* 3650)	5522 (2510)	* 4312 (* 1960)	4004 (1820)	23.95' (7.30 m)
5' (1.5 m)			* 20438 (* 9290)	14652 (6660)	12144 (5520)	8008 (3640)	7744 (3520)	5258 (2390)	* 4576 (* 2080)	3784 (1720)	24.44' (7.45 m)
Ground Level			* 18370 (* 8350)	13662 (6210)	11616 (5280)	7546 (3430)	7502 (3410)	5038 (2290)	* 5170 (* 2350)	3828 (1740)	23.91' (7.29 m)
-5' (-1.5 m)	* 11440 (* 5200)	* 11440 (* 5200)	* 22286 (* 10130)	13442 (6110)	11374 (5170)	7326 (3330)	7392 (3360)	4928 (2240)	6204 (2820)	4180 (1900)	22.28' (6.79 m)
-10' (-3.0 m)	* 18040 (* 8200)	* 18040 (* 8200)	* 21010 (* 9550)	13574 (6170)	11418 (5190)	7370 (3350)			7700 (3500)	5148 (2340)	19.25' (5.87 m)
-15' (-4.5 m)			* 14520 (* 6600)	14102 (6410)					* 9750 (* 4420)	8382 (3810)	13.92' (4.24 m)

A Distance from center of rotation  
B Height

NOTE: Lifting capacities are in compliance with SAE 1097 and ISO 10567. Machine in lifting mode with power boost turned on. Load point is the end of the arm. Rated loads shown do not exceed 75% of minimum tipping loads or 87% of hydraulic capacities. Rated loads marked with an asterisk (\*) are limited by hydraulic capacities. The least stable position is over the side. The total mass of machine includes the mass of the boom, arm, counterweight, all operating fluids and 165 lb. (75 kg) operator.

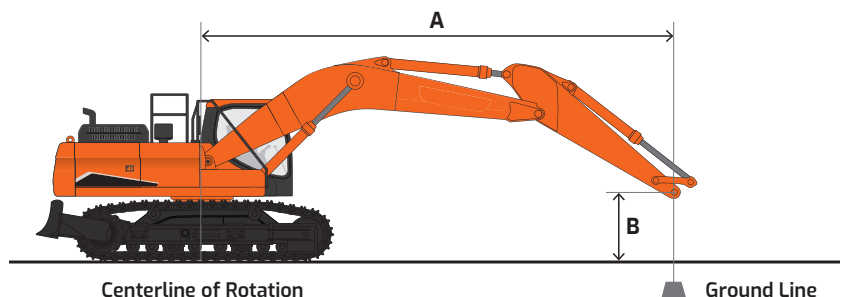











# Lifting Capacity

 Rating over front     Rating over side or 360°











## DX140LCR-7 US20

Boom: 15' 1" (4600 mm) | Arm: 9' 10" (3000 mm) | Counterweight: 7040 lb. (3200 kg) | 28" (700 mm) Shoes | Dozer Up | Bucket: None | Unit: lb. (kg)

B (ft. or m) A (ft. or m)	5' (1.5 m)		10' (3.0 m)		15' (4.5 m)		20' (6.0 m)		Max. Reach		
											A
25' (7.5 m)									* 5340 (* 2427)	* 5340 (* 2427)	14.24' (4.34 m)
20' (6.0 m)					* 7230 (* 3286)	* 7230 (* 3286)			* 4520 (* 2050)	* 4520 (* 2050)	19.41' (5.91 m)
15' (4.5 m)					* 7860 (* 3572)	* 7860 (* 3572)	* 7070 (* 3214)	5810 -2641	* 4280 (* 1945)	* 4280 (* 1945)	22.37' (6.82 m)
10' (3.0 m)			* 12820 (* 5827)	* 12820 (* 5827)	* 10500 (* 4772)	8750 -3977	8180 (* 3718)	5630 -2559	* 4330 (* 1968)	4100 -1864	23.95' (7.30 m)
5' (1.5 m)			* 20480 (* 9309)	14910 -6777	12380 -5627	8160 -3709	7900 -3591	5370 -2441	* 4600 (* 2091)	3870 -1759	24.44' (7.45 m)
Ground Level			* 18400 (* 8363)	13940 -6336	11850 -5386	7700 -3500	7660 -3482	5150 -2340	* 5180 (* 2354)	3910 -1777	23.91' (7.29 m)
-5' (-1.5 m)	* 11460 (* 5209)	* 11460 (* 5209)	* 22320 (* 10145)	13710 -6231	11600 -5272	7490 -3404	7540 -3427	5040 -2290	6300 -2864	4280 -1945	22.28' (6.79 m)
-10' (-3.0 m)	* 18070 (* 8213)	* 18070 (* 8213)	* 21060 (* 9572)	13850 -6295	11640 -5291	7520 -3418			7860 -3573	5270 -2350	19.25' (5.87 m)
-15' (-4.5 m)			* 14550 (* 6613)	14370 -6531					* 9760 (* 4436)	8550 -3886	13.92' (4.24 m)

## DX140LCR-7 US50

Boom: 15' 1" (4600 mm) | Arm: 9' 10" (3000 mm) | Counterweight: 7040 lb. (3200 kg) | 28" (700 mm) Shoes | Dozer Down | Bucket: None | Unit: lb. (kg)

B (ft. or m) A (ft. or m)	5' (1.5 m)		10' (3.0 m)		15' (4.5 m)		20' (6.0 m)		Max. Reach		
											A
25' (7.5 m)									* 5340 (* 2427)	* 5340 (* 2427)	14.24' (4.34 m)
20' (6.0 m)					* 7230 (* 3286)	* 7230 (* 3286)			* 4520 (* 2050)	* 4520 (* 2050)	19.41' (5.91 m)
15' (4.5 m)					* 7860 (* 3572)	* 7860 (* 3572)	* 7070 (* 3214)	* 7070 (* 3214)	* 4280 (* 1945)	* 4280 (* 1945)	22.37' (6.82 m)
10' (3.0 m)			* 12820 (* 5827)	* 12820 (* 5827)	* 10500 (* 4772)	* 10500 (* 4772)	* 8900 (* 4045)	7570 -3441	* 4330 (* 1968)	* 4330 (* 1968)	23.95' (7.30 m)
5' (1.5 m)			* 20480 (* 9309)	* 20480 (* 9309)	* 13170 (* 5986)	11260 -5118	* 10350 (* 4704)	7300 -3818	* 4600 (* 2091)	* 4600 (* 2091)	24.44' (7.45 m)
Ground Level			* 18400 (* 8363)	* 18400 (* 8363)	* 15140 (* 6882)	10760 -4891	* 11270 (* 5123)	7070 -3214	* 5180 (* 2354)	* 5180 (* 2354)	23.91' (7.29 m)
-5' (-1.5 m)	* 11460 (* 5209)	* 11460 (* 5209)	* 22320 (* 10145)	20540 -9336	* 15620 (* 7100)	10520 -4782	* 11380 (* 5173)	6960 -3164	* 6300 (* 2864)	5870 -2668	22.28' (6.79 m)
-10' (-3.0 m)	* 18070 (* 8213)	* 18070 (* 8213)	* 21060 (* 9572)	20710 -9414	* 14220 (* 6464)	10550 -4795			* 8910 (* 4050)	7250 -3295	19.25' (5.87 m)
-15' (-4.5 m)			* 14550 (* 6613)	* 14550 (* 6613)					* 9760 (* 4436)	* 9760 (* 4436)	13.92' (4.24 m)

A Distance from center of rotation  
B Height

NOTE: Lifting capacities are in compliance with SAE 1097 and ISO 10567. Machine in lifting mode with power boost turned on. Load point is the end of the arm. Rated loads shown do not exceed 75% of minimum tipping loads or 87% of hydraulic capacities. Rated loads marked with an asterisk (\*) are limited by hydraulic capacities. The least stable position is over the side. The total mass of machine includes the mass of the boom, arm, counterweight, all operating fluids and 165 lb. (75 kg) operator.

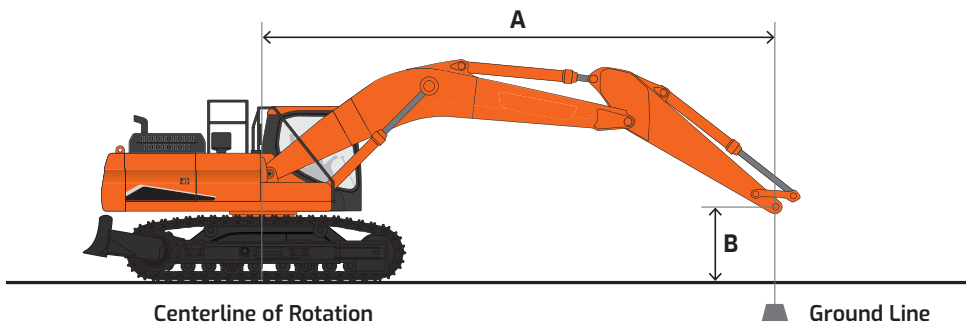

# Standard & Optional Equipment

■ Standard ● Optional

## Engine

Emissions	T4f
High-pressure common-rail (HPCR)	■
Turbo, waste gate (WGT)	■
Diesel oxidation catalyst (DOC)	■
Selective catalyst reduction (SCR)	■
Diesel exhaust fluid (DEF)	■
Fuel filter with water separator	■
Coolant expansion tank	■
Dual element dry-type air filter with evacuator	■
Electronic engine control (ECU)	■
Auto idle	■
Auto shutdown (time-adjustable)	■
Overheat & low oil pressure engine protection	■
Block heater (110 V)	●
Water separator with heater	●
Fuel filler pump	●

## Hydraulic

Electronic Power Optimizing System (EPOS)	■
Variable axial piston main pump (tandem)	■
Cross-sensing pump control	■
Pilot-operated control valves	■
Gear pilot pump	■
Smart Power Control (SPC)	■
Variable-speed hydraulic cooling fan	■
Axial piston swing motor	■
Spring-applied hydraulic release brake, swing motor	■
Axial piston travel motor (high/low, auto)	■
Auxiliary hydraulics, one- & two-way piping	■
Auxiliary hydraulics, tilt/rotate piping	●
Adjustable auxiliary flow & pressure, 10 presets	■
Breaker filter	■
Boom & arm lock valves	●
Clamshell piping	●
Straight travel	●

## Controls

Joystick controls	■
Pattern control change valve (SAE, ISO)	■
Joystick attachment control	■
Switches/buttons	■
- Right (one-way, two-way, power boost)	■
- Left (tilt/rotate, horn, one-touch decel)	■
Foot pedal attachment control	■
Control stands	■
- Height adjustable	■
- Sliding (fore/aft)	■
- Tilting armrests	■
Engine speed control dial	■
Travel pedals with hand levers	■
Straight travel pedal	●
Switches, console-mounted	■
- Starter button switch	■
- Travel speed selector	■
- Work light	■
- Auxiliary mode switch	■
Emergency stop switch	■
Power modes (P+, P, S, E)	■
Work modes (digging, lifting, breaker, shear)	■
Smart Power Control (SPC)	■
Jog dial display control	■
Wiper control panel	■
Audio control panel	■

## Cabin

Steel, all-weather & sound-suppressed	■
ROPS (ISO 12117-2:2008)	■
Viscous mount with spring reinforcement	■
Front window with wiper/washer	■
Tinted safety glass	■
Skylight top hatch with sun screen	■
Front window with sun screen	■
Pull-up type top front window	■
Removable lower front window with storage behind seat	■
Adjustable sliding side door window	■
Defrost, front window	■
Lockable doors	■
Seat	■
- Heated	■
- Air suspension	■
- 2" (51 mm) seat belt	■
- Adjustable height & recline	■
- Adjustable fore/aft	■
- Adjustable armrests	■
Leatherette seat	■
- Heating & cooling	■
- Air suspension	■
- 2" (51 mm) seat belt	●
- Adjustable height & recline	■
- Adjustable fore/aft	■
- Adjustable armrests	■
3" (76 mm) seat belt	●
Control stands	■
- Height adjustable	■
- Mounted to seat base	■
Storage for operator's manuals	■
Mirrors	■
Fully automatic HVAC with ambient temperature sensor	■
8" multi-function LCD interactive display monitor	■
Cigarette lighter	■
Digital audio broadcasting stereo	■
Speakers (2)	■
Antenna, roof-mounted	■
Emergency breakout tool	■
Hot/cold beverage compartment	■
Power socket, 12 V & 24 V	■
Cup holder	■
Interior light	■
Coat hanger	■
Rain shield	●
Fog guard	●
Front window guard	●

## Electrical

System voltage – 24 V	■
Alternator – 24 V, 80 amp	■
2 x 12 V batteries, 150 AH reserve capacity, 950 CCA	■
Blade-type fuse panel	■
Main circuit breaker	■
Light, work (LED): machine (2), boom (2)	■
Light, work (LED): 6 cab top, front (4), rear (2)	●
Light, work (LED): 4 cab top, front (2), rear (2)	●
Rotating beacon	●
Overload warning alarm	●
Hour meter	■
Engine restart prevention system	■
Side view & rearview camera with LED lamps (3)	■
360° all-around view camera	●
Microphone & speaker	●
Laptop service port	■
Self-diagnostics system	■
Smart key (remote ignition key)	■
DEVELON Fleet Management	■

## Display Monitor & Warnings

Indicators	■
- Work modes (P+, P, S, E)	■
- User/Service menu	■
Gauges	■
- Fuel level	■
- DEF level	■
- Engine coolant temperature	■
- Hydraulic oil temperature	■
- Engine rpm	■
- Battery voltage	■
- Hydraulic pump pressure	■
- ECO	■
- Digital clock	■
- Trip meter	■
- Hour meter	■
- Fuel consumption	■
Warning & indicator lights	■
- Seat belt	■
- Error code	■
- SCR warning	■
- Check engine	■
- Engine oil pressure	■
- Engine pre-heat engaged	■
- Radiator coolant level & temperature	■
- Air filter	■
- Fuel level	■
- DEF level – low	■
- Water in fuel	■
- Battery charge	■
- Work lights on	■
- Hydraulic oil temperature	■
- Hydraulic charge pressure	■
- Hydraulic pilot filter	■
- Hydraulic return filter	■
Swing alarm	■
Travel alarm	■
Buzzer	■
- Engine oil pressure	■
- Coolant temperature	■

## Undercarriage

Track guards & chains with adjusters	■
Track rollers, upper	1
Track rollers, lower	7
In-shoe motor protection	■
Shoes, triple grouser – 500 mm, rubber shoe (road liner)	●
Shoes, triple grouser – 500 mm	●
Shoes, triple grouser – 600 mm	■
Shoes, triple grouser – 700 mm	●
Dozer blade, front	●

## Other

Centralized lubrication	■
- Boom	■
- Swing	■
Handrails & service platforms	■
Skid-resistant steps & service platforms	■
Manuals	■
- Operation & Maintenance	■
- Parts	■
- AEM Safety Manual	■
DEVELON Fleet Management 3-year subscription	■
Vandalism protection	■
- Lockable panels	■
- Lockable fluid fill points	●
- Anti-theft protection (password)	■
- Vandalism window cover mount	■

Certain specification(s) are based on engineering calculations and are not actual measurements. Specification(s) are provided for comparison purposes only and are subject to change without notice. Specification(s) for your individual DEVELON equipment will vary based on normal variations in design, manufacturing, operating conditions, and other factors. Pictures of DEVELON units may show other than standard equipment.

# Powered by Innovation

# DEVELON

A brand of HD Hyundai Infracore.

[na.develon-ce.com/dx140lcr-7](http://na.develon-ce.com/dx140lcr-7)

DX140LCR-7 Crawler Excavator Spec Sheet  
Printed in the U.S.A.  
23906\_002\_D081123

©2023 HD Hyundai Infracore. All rights reserved.