

# DEVELON

## Wheel Excavator

# DX210W-7



### Engine

Make	DEVELON
Model	DL06V
Number of cylinders	6
Rated power, gross (hp per SAE J1995)	189 hp (141 kW) @ 1900 rpm
Rated power, net (hp per SAE J1349)	171 hp (128 kW) @ 1900 rpm
Max. torque, gross (SAE J1995)	593 ft.-lb. (804 Nm) @ 1400 rpm
Piston displacement	359 in. <sup>3</sup> (5.9 L)
Bore and stroke	3.9 in. x 4.9 in. (100 mm x 125 mm)
Starter	24 V, 8.6 hp (6.0 kW)
Battery (qty 2)	12 V, 150 AH
Alternator	24 V, 100 amp
Air cleaner	Three-stage

### Hydraulics

Main pumps	2 x 53.1 gpm (2 x 201 L/min.)
Pilot pump (gear design)	7.2 gpm (27.4 L/min.)

### Working Pressure

Boom/arm/bucket (normal mode)	5076 psi (357 kg/cm <sup>2</sup> )
Boom/arm/bucket (power boost)	5366 psi (377 kg/cm <sup>2</sup> )
Travel	5366 psi (377 kg/cm <sup>2</sup> )
Swing	3989 psi (280 kg/cm <sup>2</sup> )
Pilot	580 psi (41 kg/cm <sup>2</sup> )

### Tires & Wheels (standard)

Type	Double
Tire specification	10.0 - 20 - 16 PR, V Pattern, TUBE
Rim specification	7.50 V x 20
Disc offset	155 mm

### Swing Mechanism

Swing speed	0 - 10 rpm
Swing torque	59224 lbf.-ft. (8188 kgf-m)

### Drive System

Travel speed (creep - low - high)	1.9 - 5.6 - 21.7 mph (3.0 - 9.0 - 35 km/h)
Traction force, max. (drawbar pull)	26455 lbf.-ft. (12000 kgf-m)
Max. grade (limited by engine lubrication)	70% (35°)

### Environment

Sound level (2000/14/EC)	101 dB(A)
Cabin sound level (ISO 6396)	70 dB(A)

### Refill Capacities

Fuel tank	91.1 gal. (345 L)	
DEF tank	8.3 gal. (31.5 L)	
Cooling system (radiator capacity)	8.6 gal. (32.4 L)	
Engine oil	7.1 gal. (27 L)	
Swing drive	1.3 gal. (5 L)	
Front axle	STD	2.5 gal. (9.6 L)
	Wide	2.9 gal. (11 L)
Front hub (2x)	0.66 gal. (2.5 L)	
Rear axle	STD	3.5 gal. (13.4 L)
	Wide	3.8 gal. (14.5 L)
Rear hub (2x)	0.66 gal. (2.5 L)	
Transmission	0.66 gal. (2.5 L)	
Hydraulic system	50.7 gal. (192 L)	
Hydraulic tank	32.8 gal. (124 L)	

NOTE: Where applicable, dimensions are in accordance with Society of Automotive Engineers (SAE) and ISO standards. Specifications and design are subject to change without notice. All dimensions are given for DEVELON excavators equipped with standard tracks and the standard front as listed. Pictures of DEVELON excavators may show other than standard equipment. All dimensions are shown in inches. Respective metric dimensions are enclosed by parentheses. DEVELON equipment is manufactured with a Quality Management System that is in compliance with ISO 9001:2008.

# Technical Specifications

## Hydraulic Cylinders

	Mono Boom (US20/30)	Articulated Boom (US40/50)
<b>Boom main (2) bore x rod diameter x stroke</b>	4.7 in. x 3.3 in. x 49.0 in. (120 mm x 85 mm x 1244 mm)	4.7 in. x 3.3 in. x 41.1 in. (120 mm x 85 mm x 1045 mm)
<b>Boom articulated (1) bore x rod diameter x stroke</b>	–	6.7 in. x 4.1 in. x 30.0 in. (170 mm x 105 mm x 763 mm)
<b>Arm* (1) bore x rod diameter x stroke</b>	5.3 in. x 3.7 in. x 57.1 in. (135 mm x 95 mm x 1450 mm)	5.3 in. x 3.9 in. x 60.6 in. (135 mm x 100 mm x 1538 mm)
<b>Bucket (STD) (1) bore x rod diameter x stroke</b>	4.7 in. x 3.1 in. x 41.7 in. (120 mm x 95 mm x 1060 mm)	
<b>Steering (1) bore x rod diameter x stroke</b>	5.3 in. x 3.7 in. x 58.7 in. (135 mm x 95 mm x 1490 mm)	5.5 in. x 3.9 in. x 65.2 in. (140 mm x 100 mm x 1655 mm)
<b>Chocking (2) bore x rod diameter x stroke</b>	3.9 in. x 3.9 in. x 6.0 in. (100 mm x 100 mm x 153 mm)	
<b>Stabilizer (2) bore x rod diameter x stroke</b>	5.1 in. x 3.1 in. x 15.6 in. (130 mm x 80 mm x 160 mm)	
<b>Dozer (2) bore x rod diameter x stroke</b>	5.1 in. x 3.1 in. x 6.3 in. (130 mm x 80 mm x 160 mm)	
<b>Outrigger (2 or 4) bore x rod diameter x stroke</b>	5.1 in. x 3.1 in. x 15.4 in. (130 mm x 80 mm x 391 mm)	

\*Does not include cushioning

The piston rods and cylinder bodies are made of high-strength steel. A shock-absorbing mechanism is fitted in all cylinders to ensure shock-free operation and extended piston life.

# Dimensions

	Mono Boom Dozer/Outriggers (2 R) (US20)		Articulated Boom Dozer/Outriggers (2 R) (US40)	
		Outriggers (2 F/2 R) (US30)		Outriggers (2 F/2 R) (US50)
Boom length	18' 4" (5600 mm)		17' 9" (5400 mm) Lower: 6' 4" (1920 mm) Upper: 12' 7" (3840 mm)	
Arm length	9' 0" (2750 mm)		7' 10" (2400 mm)	
Bucket type (SAE) (PCSA)	1.12 yd <sup>3</sup> (0.86 m <sup>3</sup> )			
Shipping length	A	31' 1" (9470 mm)		30' 6" (9300 mm)
Shipping width	B	8' 4" (2530 mm)		
Shipping height (hose)	C	10' 1" (3085 mm)	9' 10" (2990 mm)	
Overall height – cab	D	10' 4" (3155 mm)		
Cabin height above house		2' 10" (853 mm)		
Tail swing radius	E	9' 1" (2777 mm)		
Ground clearance	F	13" (337 mm)		
Counterweight clearance	G	4' 2" (1258 mm)		
Engine cover height	H	-		
Upper housing width	I	8' 4" (2530 mm)		
Wheel base	J	9' 4" (2850 mm)		
Tread width	K	6' 3" (1914 mm)		
Tread width wide angle		6' 11" (2114 mm)		
Blade width*	8' 4" (2530 mm)	-	8' 4" (2530 mm)	-
Blade width wide axle*	9' 0" (2750 mm)	-	9' 0" (2750 mm)	-
Overall undercarriage length*	16' 8" (5080 mm)	16' 3" (4965 mm)	16' 8" (5080 mm)	16' 3" (4965 mm)
Outrigger length (rear)*	3' 3" (999 mm)			
Outrigger length (front)*	-	3' 8" (1116 mm)	-	3' 8" (1116 mm)
Blade length (front)*	4' 0" (1231 mm)	-	4' 0" (1231 mm)	-
Blade clearance (raised)*	1' 6" (445 mm)	-	1' 6" (445 mm)	-
Blade height*	2' 1" (630 mm)	-	2' 1" (630 mm)	-
Max. blade depth*	4.9" (125 mm)	-	4.9" (125 mm)	-
Outrigger width (ground)*	11' 4" (3465 mm)			
Outrigger width (max. depth)*	11' 11" (3640 mm)			
Max. outrigger depth*	3.5" (90 mm)			
Tire size	10.0 – 20 – 16 PR			

\*Not shown on diagram

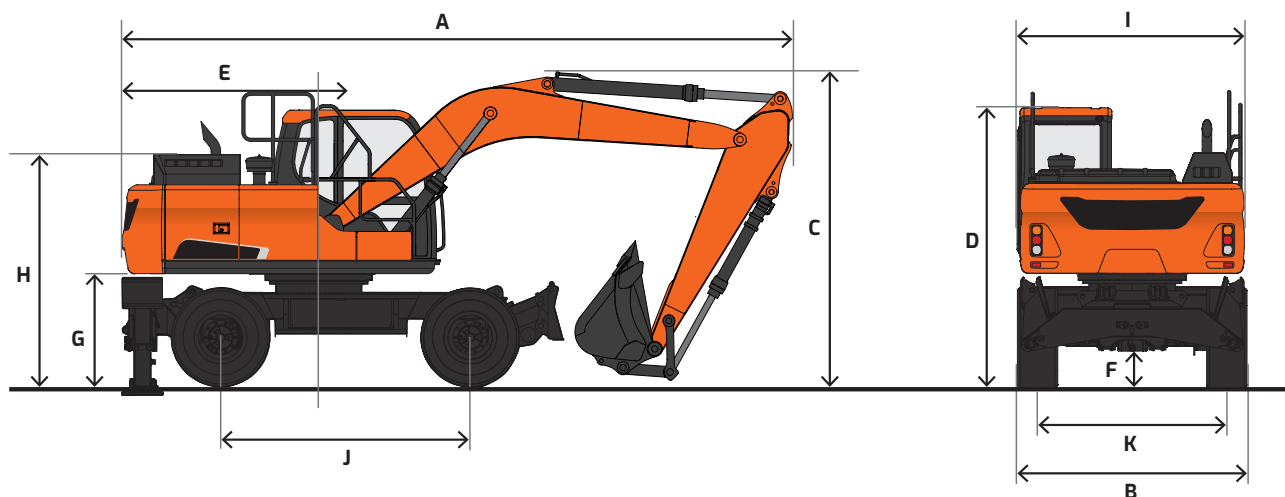

# Working Range

	Mono Boom Dozer/Outriggers (2 R) (US20)		Outriggers (2 F/2 R) (US30)	Articulated Boom Dozer/Outriggers (2 R) (US40)		Outriggers(2 F/2 R) (US50)
	Boom length	18' 4" (5600 mm)			17' 9" (5400 mm) Lower: 6' 4" (1940 mm) Upper: 12' 7" (3840 mm)	
Arm length	9' 0" (2750 mm)			7' 10" (2400 mm)		
Bucket type (SAE, PCSA)	1.12 yd <sup>3</sup> (0.86 m <sup>3</sup> )					
Max. digging reach	A	31' 10" (9705 mm)		30' 11" (9415 mm)		
Max. digging reach (ground)	B	31' 2" (9505 mm)		30' 2" (9205 mm)		
Max. digging depth	C	19' 4" (5905 mm)		18' 5" (5605 mm)		
Max. loading height	D	23' 4" (7115 mm)		25' 0" (7620 mm)		
Min. loading height	E	9' 4" (2840 mm)		11' 1" (3390 mm)		
Max. digging height	F	32' 5" (9870 mm)		34' 7" (10,530 mm)		
Max. bucket pin height	G	28' 1" (8570 mm)		29' 9" (9075 mm)		
Max. vertical wall depth	H	17' 4" (5280 mm)		10' 1" (3065 mm)		
Max. radius vertical	I	20' 11" (6365 mm)		25' 7" (7805 mm)		
Max. depth to 8' line	J	18' 9" (5715 mm)		18' 1" (5500 mm)		
Min. radius to 8' line	K	10' 5" (3180 mm)		2' 9" (835 mm)		
Min. digging reach	L	2' 9" (850 mm)		-		
Min. swing radius	M	10' 10" (3300 mm)		10' 8" (3260 mm)		
Digging force, bucket*	SAE	29983 lbf. (13600 kgf)		25353 lbf. (11500 kgf)		
Digging force, arm*		22708 lbf. (10300 kgf)				
Operating weight		50706 lb. (23000 kg)	51623 lb. (23416 kg)	50684 lb. (22990 kg)	51601 lb. (23406 kg)	

\*With power boost ON

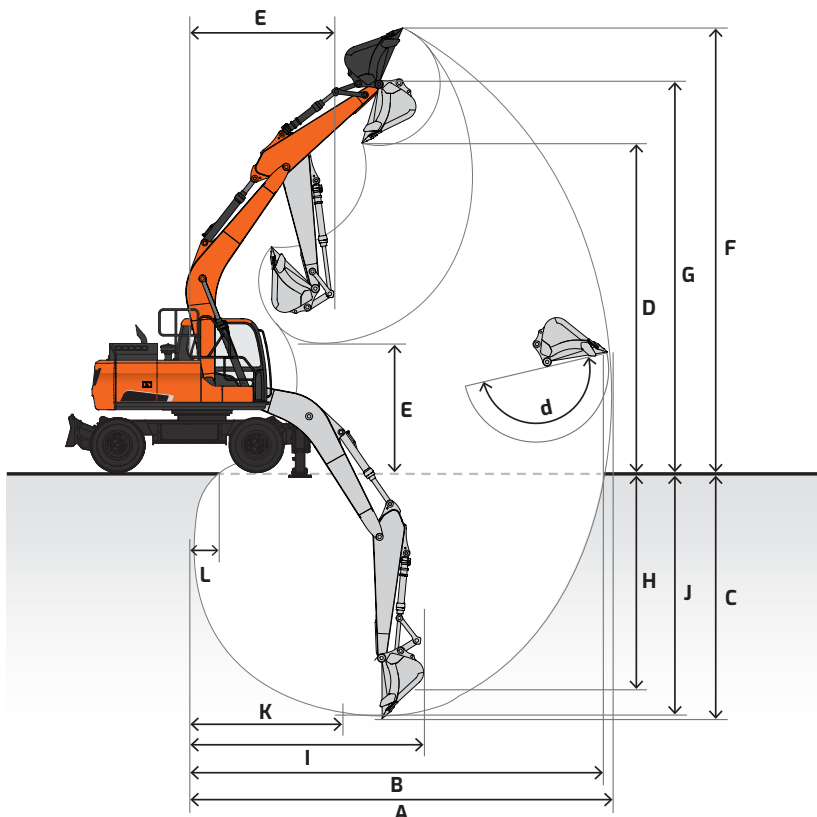













# Lifting Capacity

 Rating over front     Rating over side or 360°













## DX210W-7 US20

Mono Boom: 18' 5" (5600 mm) | Arm: 9' 0" (2750 mm) | Counterweight: 8800 lb. (4000 kg) | Front Dozer & Rear Outriggers UP | Bucket: None | Unit: lb. (kg)

B (ft. or m) A (ft. or m)	5' (1.5 m)		10' (3.0 m)		15' (4.5 m)		20' (6.0 m)		25' (7.5 m)		Max. Reach		
													A
25' (7.5 m)							* 10360 (* 4700)	9010 (4090)			* 10030 (* 4550)	8910 (4040)	19.67' (6.00 m)
20' (6.0 m)							* 13530 (6140)	9040 (4100)			* 9320 (* 4230)	6690 (3040)	23.41' (7.14 m)
15' (4.5 m)					* 17730 (* 8040)	13370 (6070)	13170 (5970)	8700 (3950)	9270 (4200)	6110 (2770)	8610 (3910)	5650 (2560)	25.67' (7.82 m)
10' (3.0 m)					19450 (8820)	12270 (5560)	12630 (5730)	8220 (3730)	9050 (4110)	5910 (2680)	7910 (3590)	5140 (2330)	26.82' (8.18 m)
5' (1.5 m)					18370 (8330)	11330 (5140)	12120 (5500)	7750 (3520)	8810 (4000)	5680 (2580)	7690 (3580)	4950 (2290)	27.04' (8.24 m)
Ground Level					17830 (8090)	10860 (4930)	11770 (5340)	7440 (3370)	8640 (3920)	5530 (2510)	7900 (3580)	5060 (2290)	26.33' (8.02 m)
-5' (-1.5 m)		* 25520 (* 11570)	19510 (8850)		17720 (8040)	10760 (4880)	11660 (5290)	7330 (3330)			8670 (3930)	5540 (2510)	24.6' (7.50 m)
-10' (-3.0 m)		* 30330 (* 13760)	19910 (9030)		17920 (8130)	10940 (4960)	11800 (5350)	7460 (3380)			10500 (4760)	6700 (3040)	21.62' (6.59 m)

## DX210W-7 US20

Mono Boom: 18' 5" (5600 mm) | Arm: 9' 0" (2750 mm) | Counterweight: 8800 lb. (4000 kg) | Front Dozer & Rear Outriggers DOWN | Bucket: None | Unit: lb. (kg)

B (ft. or m) A (ft. or m)	5' (1.5 m)		10' (3.0 m)		15' (4.5 m)		20' (6.0 m)		25' (7.5 m)		Max. Reach		
													A
25' (7.5 m)							* 10360 (* 4700)	* 10360 (* 4700)			* 10030 (* 4550)	* 10030 (* 4550)	19.67' (6.00 m)
20' (6.0 m)							* 13800 (* 6260)	* 13800 (* 6260)			* 9320 (* 4230)	* 9320 (* 4230)	23.41' (7.14 m)
15' (4.5 m)					* 17730 (* 8040)	* 17730 (* 8040)	* 15000 (* 6810)	13810 (6270)	* 12810 (* 5810)	9720 (4410)	* 9190 (* 4170)	9030 (4100)	25.67' (7.82 m)
10' (3.0 m)					* 21950 (* 9960)	20540 (9310)	* 16860 (* 7650)	13270 (6020)	* 14360 (* 6510)	9500 (4310)	* 9450 (* 4290)	8300 (3770)	26.82' (8.18 m)
5' (1.5 m)					* 25370 (* 11510)	19430 (8820)	* 18580 (* 8430)	12750 (5780)	* 15080 (* 6840)	9250 (4200)	* 10120 (* 4590)	8070 (3660)	27.04' (8.24 m)
Ground Level					* 26540 (* 12040)	18880 (8570)	* 19450 (* 8820)	12400 (5630)	* 15310 (* 6940)	9080 (4120)	* 11360 (* 5150)	8300 (3760)	26.33' (8.02 m)
-5' (-1.5 m)		* 25520 (* 11570)	* 25520 (* 11570)		* 25540 (* 11590)	18770 (8510)	* 18990 (* 8610)	12280 (5570)			* 13650 (* 6190)	9110 (4130)	24.6' (7.50 m)
-10' (-3.0 m)		* 30330 (* 13760)	* 30330 (* 13760)		* 22320 (10120)	18980 (8610)	* 16410 (* 7440)	12430 (5640)			* 14130 (* 6410)	11040 (5010)	21.62' (6.59 m)

A Distance from center of rotation

B Height

NOTE: Lifting capacities are in compliance with SAE 1097 and ISO 10567. Machine in lifting mode with power boost turned on. Load point is the end of the arm. Rated loads shown do not exceed 75% of minimum tipping loads or 87% of hydraulic capacities. Rated loads marked with an asterisk (\*) are limited by hydraulic capacities. The least stable position is over the side. The total mass of machine includes the mass of the boom, arm, counterweight, all operating fluids and 165 lb. (75 kg) operator.

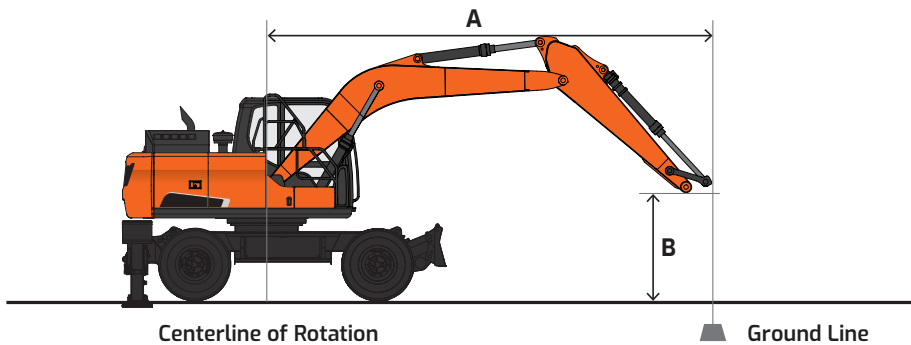













# Lifting Capacity

 Rating over front     Rating over side or 360°













## DX210W-7 US30

Mono Boom: 18' 5" (5600 mm) | Arm: 9' 0" (2750 mm) | Counterweight: 8800 lb. (4000 kg) | Front & Rear Outriggers UP | Bucket: None | Unit: lb. (kg)

A (ft. or m) B (ft. or m)	5' (1.5 m)		10' (3.0 m)		15' (4.5 m)		20' (6.0 m)		25' (7.5 m)		Max. Reach		
													A
25' (7.5 m)							* 10360 (* 4700)	* 9050 (4110)			* 10030 (* 4550)	8950 (4060)	19.67' (6.00 m)
20' (6.0 m)							* 13510 (6130)	9080 (4120)			* 9320 (* 4230)	6720 (3050)	23.41' (7.14 m)
15' (4.5 m)					* 17730 (8040)	13430 (6090)	13150 (5960)	8740 (3970)	9250 (4200)	6140 (2800)	8600 (3900)	5680 (2580)	25.67' (7.82 m)
10' (3.0 m)					19420 (8810)	12320 (5590)	12610 (5720)	8260 (3750)	9040 (4100)	5940 (2690)	7900 (3580)	5160 (2340)	26.82' (8.18 m)
5' (1.5 m)					18340 (8320)	11390 (5160)	12100 (5490)	7790 (3530)	8800 (3910)	5710 (2520)	7680 (3480)	4980 (2260)	27.04' (8.24 m)
Ground Level					17800 (8070)	10920 (4950)	11750 (5330)	7480 (3390)	8630 (3910)	5560 (2520)	7880 (3580)	5090 (2310)	26.33' (8.02 m)
-5' (-1.5 m)		* 25520 (* 11570)	19610 (8890)		17690 (8020)	10820 (4910)	11640 (5280)	7370 (3340)			8650 (3920)	5570 (2530)	24.6' (7.50 m)
-10' (-3.0 m)		* 30330 (* 13760)	20020 (9080)		17890 (8110)	11000 (4990)	11780 (5340)	7500 (3400)			10480 (4750)	6740 (3060)	21.62' (6.59 m)

## DX210W-7 US30

Mono Boom: 18' 5" (5600 mm) | Arm: 9' 0" (2750 mm) | Counterweight: 8800 lb. (4000 kg) | Front & Rear Outriggers DOWN | Bucket: None | Unit: lb. (kg)

A (ft. or m) B (ft. or m)	5' (1.5 m)		10' (3.0 m)		15' (4.5 m)		20' (6.0 m)		25' (7.5 m)		Max. Reach		
													A
25' (7.5 m)							* 10360 (* 4700)	* 10360 (* 4700)			* 10030 (* 4550)	* 10030 (* 4550)	19.67' (6.00 m)
20' (6.0 m)							* 13800 (* 6260)	* 13800 (* 6260)			* 9320 (* 4230)	* 9320 (* 4230)	23.41' (7.14 m)
15' (4.5 m)					* 17730 (* 8040)	* 17730 (* 8040)	* 15000 (* 6810)	* 15000 (* 6810)	* 12810 (* 5810)	11710 (5310)	* 9190 (* 4170)	* 9190 (* 4170)	25.67' (7.82 m)
10' (3.0 m)					* 21950 (* 9960)	* 21950 (* 9960)	* 16860 (* 7650)	16170 (7330)	* 14360 (* 6510)	11480 (5210)	* 9450 (* 4290)	* 9450 (* 4290)	26.82' (8.18 m)
5' (1.5 m)					* 25370 (* 11510)	24450 (11090)	* 18580 (* 8430)	15620 (7080)	* 15080 (* 6840)	11230 (5090)	* 10120 (* 4590)	9780 (4440)	27.04' (8.24 m)
Ground Level					* 26540 (* 12040)	23850 (10820)	* 19450 (* 8820)	15250 (6920)	* 15310 (* 6940)	11050 (5010)	* 11360 (* 5150)	10070 (4570)	26.33' (8.02 m)
-5' (-1.5 m)		* 25520 (* 11570)	* 25520 (* 11570)		* 25540 (* 11590)	23730 (10760)	* 18990 (* 8610)	15120 (6860)			* 13650 (* 6190)	11080 (5030)	24.6' (7.50 m)
-10' (-3.0 m)		* 30330 (* 13760)	* 30330 (* 13760)		* 22320 (* 10120)	* 22320 (* 10120)	* 16410 (* 7440)	15280 (6930)			* 14130 (* 6410)	13490 (6120)	21.62' (6.59 m)

A Distance from center of rotation

B Height

NOTE: Lifting capacities are in compliance with SAE 1097 and ISO 10567. Machine in lifting mode with power boost turned on. Load point is the end of the arm. Rated loads shown do not exceed 75% of minimum tipping loads or 87% of hydraulic capacities. Rated loads marked with an asterisk (\*) are limited by hydraulic capacities. The least stable position is over the side. The total mass of machine includes the mass of the boom, arm, counterweight, all operating fluids and 165 lb. (75 kg) operator.

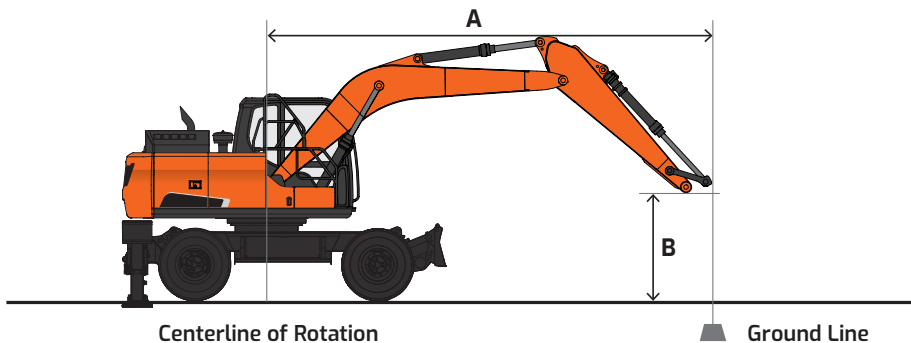













# Lifting Capacity

 Rating over front     Rating over side or 360°













## DX210W-7 US40

2-PC Boom: 18' 5" (5426 mm) | Arm: 7' 10" (2400 mm) | Counterweight: 8800 lb. (4000 kg) | Front Dozer & Rear Outriggers UP | Bucket: None | Unit: lb. (kg)

A (ft. or m) B (ft. or m)	5' (1.5 m)		10' (3.0 m)		15' (4.5 m)		20' (6.0 m)		25' (7.5 m)		Max. Reach		
													A
30' (9.0 m)											* 14570 (* 6610)	* 14570 (* 6610)	11.05' (3.37 m)
25' (7.5 m)					* 11080 (* 5030)	* 11080 (* 5030)					* 9800 (* 4440)	* 9800 (* 4440)	18.32' (5.59 m)
20' (6.0 m)					* 11350 (* 5150)	* 11350 (* 5150)	* 11300 (* 5130)	8940 (4060)			* 8390 (* 3800)	7170 (3250)	22.28' (6.79 m)
15' (4.5 m)					* 13850 (* 6280)	13320 (6040)	* 12150 (* 5510)	8690 (3940)	* 8220 (* 3730)	6030 (2740)	* 7810 (* 3540)	6010 (2730)	24.65' (7.51 m)
10' (3.0 m)					* 17790 (* 8070)	12270 (5570)	12710 (5760)	8250 (3740)	9120 (4140)	5940 (2690)	* 7660 (* 3470)	5470 (2480)	25.86' (7.88 m)
5' (1.5 m)					18530 (8410)	11420 (5180)	12250 (5560)	7830 (3550)	8930 (4050)	5770 (2620)	* 7840 (* 3560)	5310 (2410)	26.08' (7.95 m)
Ground Level					18090 (8210)	11030 (5000)	11960 (5430)	7570 (3440)	8830 (4010)	5670 (2570)	* 8390 (* 3800)	5480 (2490)	25.33' (7.72 m)
-5' (-1.5 m)					18070 (8200)	11010 (5000)	11920 (5410)	7530 (3420)			9470 (4290)	6100 (2760)	23.54' (7.17 m)

## DX210W-7 US40

2-PC Boom: 18' 5" (5426 mm) | Arm: 7' 10" (2400 mm) | Counterweight: 8800 lb. (4000 kg) | Front Dozer & Rear Outriggers DOWN | Bucket: None | Unit: lb. (kg)

A (ft. or m) B (ft. or m)	5' (1.5 m)		10' (3.0 m)		15' (4.5 m)		20' (6.0 m)		25' (7.5 m)		Max. Reach		
													A
30' (9.0 m)											* 14570 (* 6610)	* 14570 (* 6610)	11.05' (3.37 m)
25' (7.5 m)					* 11080 (* 5030)	* 11080 (* 5030)					* 9800 (* 4440)	* 9800 (* 4440)	18.32' (5.59 m)
20' (6.0 m)					* 11350 (* 5150)	* 11350 (* 5150)	* 11300 (* 5130)	* 11300 (* 5130)			* 8390 (* 3800)	* 8390 (* 3800)	22.28' (6.79 m)
15' (4.5 m)					* 13850 (* 6280)	* 13850 (* 6280)	* 12150 (* 5510)	* 12150 (* 5510)	* 8220 (* 3730)	* 8220 (* 3730)	* 7810 (* 3540)	* 7810 (* 3540)	24.65' (7.51 m)
10' (3.0 m)					* 17790 (* 8070)	* 17790 (* 8070)	* 13880 (* 6300)	* 13880 (* 6300)	* 12380 (* 5620)	9570 (4530)	* 7660 (* 3470)	* 7660 (* 3470)	25.86' (7.88 m)
5' (1.5 m)					* 21520 (* 9760)	19610 (9370)	* 15780 (* 7160)	12890 (6120)	* 13240 (* 6010)	9380 (4450)	* 7840 (* 3560)	* 7840 (* 3560)	26.08' (7.95 m)
Ground Level					* 23630 (* 10720)	19160 (9160)	* 17200 (* 7800)	12600 (5990)	* 13900 (* 6300)	9280 (4400)	* 8390 (* 3810)	* 8390 (* 3810)	25.33' (7.72 m)
-5' (-1.5 m)					* 24020 (* 10900)	19130 (9150)	* 17670 (* 8010)	12550 (5970)			* 9520 (* 4320)	* 9520 (* 4320)	23.54' (7.17 m)

A Distance from center of rotation  
B Height

NOTE: Lifting capacities are in compliance with SAE 1097 and ISO 10567. Machine in lifting mode with power boost turned on. Load point is the end of the arm. Rated loads shown do not exceed 75% of minimum tipping loads or 87% of hydraulic capacities. Rated loads marked with an asterisk (\*) are limited by hydraulic capacities. The least stable position is over the side. The total mass of machine includes the mass of the boom, arm, counterweight, all operating fluids and 165 lb. (75 kg) operator.

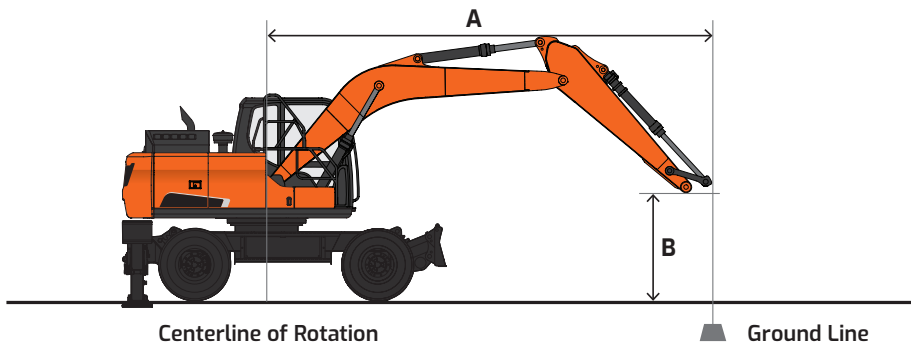













# Lifting Capacity

 Rating over front     Rating over side or 360°













## DX210W-7 US50

2-PC Boom: 18' 5" (5426 mm) | Arm: 7' 10" (2400 mm) | Counterweight: 8800 lb. (4000 kg) | Front & Rear Outriggers UP | Bucket: None | Unit: lb. (kg)

A (ft. or m) B (ft. or m)	5' (1.5 m)		10' (3.0 m)		15' (4.5 m)		20' (6.0 m)		25' (7.5 m)		Max. Reach		
													A
30' (9.0 m)											* 14570 (* 6610)	* 14570 (* 6610)	11.05' (3.37 m)
25' (7.5 m)					* 11080 (* 5030)	* 11080 (* 5030)					* 9800 (* 4440)	* 9800 (* 4440)	18.32' (5.59 m)
20' (6.0 m)					* 11350 (* 5150)	* 11350 (* 5150)	* 11300 (* 5130)	8990 (4080)			* 8390 (* 3800)	7210 (3270)	22.28' (6.79 m)
15' (4.5 m)					* 13850 (* 6280)	13380 (6070)	* 12150 (* 5510)	8730 (3960)	* 8220 (* 3730)	6060 (2750)	* 7810 (* 3540)	6040 (2740)	24.65' (7.51 m)
10' (3.0 m)					* 17790 (* 8070)	12330 (5590)	12690 (5760)	8290 (3760)	9100 (4130)	5970 (2710)	* 7660 (* 3470)	5500 (2490)	25.86' (7.88 m)
5' (1.5 m)					18500 (8390)	11480 (5210)	12230 (5550)	7870 (3570)	8920 (4040)	5800 (2630)	* 7840 (* 3560)	5340 (2420)	26.08' (7.95 m)
Ground Level					18060 (8190)	11090 (5030)	11940 (5420)	7620 (3450)	8820 (4000)	5710 (2590)	* 8390 (* 3800)	5510 (2500)	25.33' (7.72 m)
-5' (-1.5 m)					18040 (8180)	11070 (5020)	11900 (5400)	7570 (3440)			9450 (4290)	6130 (2780)	23.54' (7.17 m)

## DX210W-7 US50

2-PC Boom: 18' 5" (5426 mm) | Arm: 7' 10" (2400 mm) | Counterweight: 8800 lb. (4000 kg) | Front & Rear Outriggers DOWN | Bucket: None | Unit: lb. (kg)

A (ft. or m) B (ft. or m)	5' (1.5 m)		10' (3.0 m)		15' (4.5 m)		20' (6.0 m)		25' (7.5 m)		Max. Reach		
													A
30' (9.0 m)											* 14570 (* 6610)	* 14570 (* 6610)	11.05' (3.37 m)
25' (7.5 m)					* 11080 (* 5030)	* 11080 (* 5030)					* 9800 (* 4440)	* 9800 (* 4440)	18.32' (5.59 m)
20' (6.0 m)					* 11350 (* 5150)	* 11350 (* 5150)	* 11300 (* 5130)	* 11300 (* 5130)			* 8390 (* 3800)	* 8390 (* 3800)	22.28' (6.79 m)
15' (4.5 m)					* 13850 (* 6280)	* 13850 (* 6280)	* 12150 (* 5510)	* 12150 (* 5510)	* 8220 (* 3730)	* 8220 (* 3730)	* 7810 (* 3540)	* 7810 (* 3540)	24.65' (7.51 m)
10' (3.0 m)					* 17790 (* 8070)	* 17790 (* 8070)	* 13880 (* 6300)	* 13880 (* 6300)	* 12380 (* 5620)	11570 (5250)	* 7660 (* 3470)	* 7660 (* 3470)	25.86' (7.88 m)
5' (1.5 m)					* 21520 (* 9760)	* 21520 (* 9760)	* 15780 (* 7160)	* 15780 (* 7160)	* 13240 (* 6010)	11380 (5160)	* 7840 (* 3560)	* 7840 (* 3560)	26.08' (7.95 m)
Ground Level					* 23630 (* 10720)	* 23630 (* 10720)	* 17200 (* 7800)	15480 (7020)	* 13900 (* 6300)	11270 (5110)	* 8390 (* 3810)	* 8390 (* 3810)	25.33' (7.72 m)
-5' (-1.5 m)					* 24020 (* 10900)	* 24020 (* 10900)	* 17670 (* 8010)	15430 (7000)			9520 (4320)	9520 (4320)	23.54' (7.17 m)

A Distance from center of rotation

B Height

NOTE: Lifting capacities are in compliance with SAE 1097 and ISO 10567. Machine in lifting mode with power boost turned on. Load point is the end of the arm. Rated loads shown do not exceed 75% of minimum tipping loads or 87% of hydraulic capacities. Rated loads marked with an asterisk (\*) are limited by hydraulic capacities. The least stable position is over the side. The total mass of machine includes the mass of the boom, arm, counterweight, all operating fluids and 165 lb. (75 kg) operator.

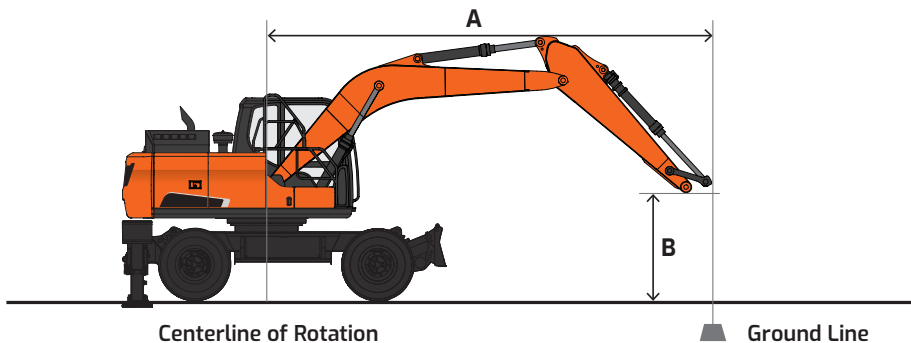



# Standard & Optional Equipment

■ Standard    ● Optional

## Engine

Emissions (EPA)	T4f
High-pressure common-rail (HPCR)	■
Turbo waste gate (WGT)	■
Cooled exhaust gas recirculation (CEGR)	■
Diesel oxidation catalyst (DOC)	■
Selective catalyst reduction (SCR)	■
Diesel exhaust fluid (DEF)	■
Fuel filter with water separator	■
Variable speed cooling fan (engine-driven with electric clutch)	■
Coolant expansion tank	■
Dual element dry-type air filter with evacuator	■
Precleaner	■
Electronic engine control (ECU)	■
Auto idle	■
Auto shutdown (time-adjustable)	■
Overheat & low oil pressure engine protection	■
Block heater (110 V), diesel-powered coolant heater	●
Water separator with heater	●
Fuel filler pump	●

## Hydraulic

Electronic Power Optimizing System (EPOS)	■
Variable axial piston main pump (tandem)	■
Cross-sensing pump control	■
Pilot-operated control valves	■
Gear pilot pump	■
Smart Power Control (SPC)	■
Axial piston swing motor	■
Spring-applied hydraulic release brake, travel	■
Spring-applied hydraulic release brake, swing motor	■
Axial piston travel motor (high/low, auto)	■
Auxiliary hydraulics, one- & two-way piping	■
Auxiliary hydraulics, tilt/rotate piping	●
Adjustable auxiliary flow & pressure, 10 presets	■
Intelligent floating boom	●
Boom & arm lock valves	●
Clamshell piping	●

## Controls

Steering wheel	■
Accelerator pedal	■
Brake pedal	■
Swing lock mechanism for traveling	■
Fine swing control	■
Joystick controls	■
Pattern control change valve (SAE, ISO BHL)	■
Joystick attachment control	■
Switches/buttons	■
- Right (one-way, two-way, power boost)	■
- Left (tilt/rotate, horn, one-touch decel)	■
Foot pedal attachment control	■
Control stands	■
- Height adjustable	■
- Sliding (fore/aft)	■
- Tilting armrests	■
Engine speed control dial	■
Switches & indicators, steering column	■
- Steering column	■
- Positional lever	■
- Work/travel selector switch	■
- Turn signal control lever	■
- Hazard warning switch	■
- Turn signal/hazard light indicators	■
- Wiper & washer control	■
- Horn button	■
- High/low beam control	■
Switches, console-mounted	■
- Starter button switch	■
- Travel speed selector	■
- Work light	■
- Auxiliary mode switch	■
Emergency stop switch	■
Power modes (P+, P, S, E)	■
Work modes (digging, lifting, breaker, shear)	■
Jog dial display control	■
Wiper control panel	■
Audio control panel	■

## Cabin

Steel, all-weather & sound-suppressed	■
ROPS (ISO 12117-2:2008)	■
Viscous mount with spring reinforcement	■
Front window panto wiper with wiper/washer	■
Tinted safety glass	■
Skylight top hatch with sun screen	■
Visor – front window skylight & rear window	■
Pull-up type top front window	■
Removable lower front window with storage behind seat	■
Adjustable sliding side door window	■
Defrost, front window	■
Lockable doors	■
Seat	■
- Heated	■
- Air suspension	■
- 2" (51 mm) seat belt	■
- Adjustable height & recline	■
- Adjustable fore/aft	■
- Adjustable armrests	■
Leatherette seat	■
- Heating & cooling	■
- Air suspension	■
- 2" (51 mm) seat belt	●
- Adjustable height & recline	●
- Adjustable fore/aft	●
- Adjustable armrests	●
3" (76 mm) seat belt	●
Control stands	■
- Height adjustable	■
- Mounted to seat base	■
Foot rest	■
Storage for operator's manuals	■
Rearview mirrors	■
Fully automatic HVAC with radian energy photo sensor	■
8" multi-function LCD interactive display monitor	■
Cigarette lighter	■
Digital audio broadcasting radio with cell phone integration	■
Speakers (2)	■
Antenna, roof-mounted	■
Emergency breakout tool	■
Hot/cold beverage compartment	■
Power socket, 12 V & 24 V	■
Front & rear cup holders	■
Interior light	■
Coat hanger	■
Rain shield	●
Fog guard	●
Front window guard	●

## Electrical

System voltage – 24 V	■
Alternator – 24 V, 100 amp	■
2 x 12 V batteries, 150 AH reserve capacity, 950 CCA	■
Blade-type fuse panel	■
Main circuit breaker	■
Light, work (LED): machine (2), boom (2)	■
Light, work (LED): 6 cab top, front (4), rear (2)	●
Light, work (LED): 4 cab top, front (2), rear (2)	●
Rotating beacon	●
Hour meter	■
Engine restart prevention system	■
Side view camera with LED lamps (3)	■
Rearview camera with LED lamps (3)	■
360° all-around view camera	●
Microphone & speaker	●
Ultrasonic sensor	●
Laptop service port	■
Self-diagnostics system	■
Smart key (remote ignition key)	■
DEVELON Fleet Management	■

## Display Monitor & Warnings

Indicators	■
- Work modes (P+, P, S, E)	■
- User/Service menu	■
Gauges	■
- Fuel level	■
- DEF level	■
- Engine coolant temperature	■
- Hydraulic oil temperature	■
- Engine rpm	■
- Battery voltage	■
- Hydraulic pump pressure	■
- ECO	■
- Digital clock	■
- Trip meter	■
- Hour meter	■
- Fuel consumption	■
Warning & indicator lights	■
- Seat belt	■
- Error code	■
- SCR warning	■
- Check engine	■
- Engine oil pressure	■
- Engine pre-heat engaged	■
- Radiator coolant level & temperature	■
- Air filter	■
- Fuel level	■
- DEF level – low	■
- Water in fuel	■
- Battery charge	■
- Work lights on	■
- Hydraulic oil temperature	■
- Hydraulic charge pressure	■
- Hydraulic pilot filter	■
- Hydraulic return filter	■
Swing alarm	■
Travel alarm	■
Buzzer	■
- Engine oil pressure	■
- Coolant temperature	■

## Undercarriage

Tire size – 10.0 – 20 – 16 ply rating	■
Transmission 2-speed power-shift with creep	■
Planetary drive front & rear axle	■
Oscillating (±8°) front axle lockable	■
Steering front axle	■
Dozer	■
Outriggers, front (in place of dozer)	●
Outriggers, rear	■
Toolbox	■

## Other

Centralized lubrication	■
- Boom	■
- Swing	■
Emergency steering	■
Handrails & service platforms	■
Skid-resistant steps & service platforms	■
Wheel chocks	■
Manuals	■
- Operation & Maintenance	■
- Parts	■
- AEM Safety Manual	■
DEVELON Fleet Management 3-year subscription	■
Vandalism protection	■
- Lockable panels	■
- Lockable fluid fill points	■
- Anti-theft protection (password)	■
- Vandalism window cover mount	■
Air compressor	●

# DEVELON

[na.develon-ce.com/dx210w-7](http://na.develon-ce.com/dx210w-7)

DX210W-7 Wheel Excavator Spec Sheet

Printed in the U.S.A.

23906\_001\_D042723

©2023 HD Hyundai Infracore. All rights reserved.  
DEVELON is a brand of HD Hyundai Infracore;  
HD Hyundai Infracore is an affiliate of HD Hyundai.